



TOWNSHIP OF KING

**King City Village Centre Urban Design Guidelines**

*FINAL REPORT - February 2006*

BROOK MCILROY  
URBAN DESIGN +  
PLANNING

Meridian Planning  
Consultants Inc.



# table of contents

<b>1.0 Introduction</b>	<b>1</b>
1.1 Context	1
1.2 Objectives	1
1.3 Guiding Principles	1
<b>2.0 King City Context Plan</b>	<b>2</b>
<b>3.0 Analysis of Existing Conditions</b>	<b>4</b>
3.1 Existing and Proposed Conditions: Streetscape	4
3.2 Existing and Proposed Conditions: Built Form	10
3.3 Comparable Precedents	12
<b>4.0 Urban Design Guidelines</b>	<b>14</b>
4.1 General Recommendations	14
4.2 Public Realm -Streetscape Elements	14
4.2.1 Gateway Features	14
4.2.2 Above Grade Utilities	15
4.2.3 Traffic Mitigation	15
4.2.4 Parking and Curb Cuts	15
4.2.5 Planting	16
4.2.6 Lighting	16
4.2.7 Street Furniture	17
4.2.8 Street Trees	17
4.2.9 Sidewalks and Planters	18
4.3 Private Realm - Built Form Elements	19
4.3.1 Massing	19
4.3.2 New Construction, Additions and Renovations	20
4.3.3 Setbacks	20
4.3.4 Rooflines	21
4.3.5 Architectural Detail	22
4.3.6 Entrance Ways	22
4.3.7 Signage	22
4.3.8 Fences	23
4.3.8 Building Materials	23
<b>5.0 Proposed Streetscape Design</b>	<b>24</b>
5.1 Street Section	24
5.2 Tree Selection	28
5.3 Plant Selection	30
5.4 Tree Protection	32
5.5 Lighting	33
5.6 Paving Material	34
5.7 Typical Site Details	36
<b>6.0 Proposed Redevelopment Areas</b>	<b>38</b>
6.1 Map of Redevelopment Areas	38
6.2 Proposed Destination Sites	40
King City Plaza	40
Hoop Street Mews	42
Doctor's Lane	43
6.3 Street Elevations showing Potential Redevelopment Areas	44
<b>7.0 Implementation</b>	<b>49</b>

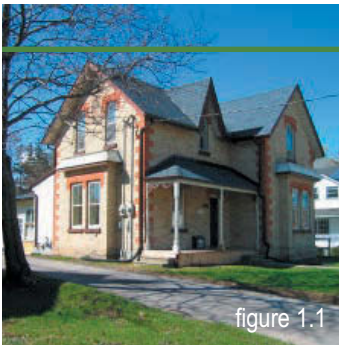

figure 1.1



figure 1.2

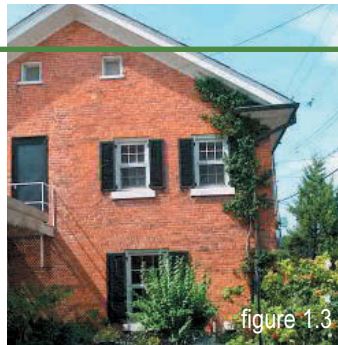

figure 1.3

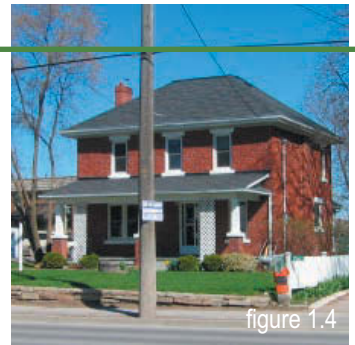

figure 1.4

Typical King City Homes: Many of these houses remain as private family dwellings.



figure 1.5



figure 1.6

These houses on King have both been beautifully restored in keeping with the style of the original building.



figure 1.7



figure 1.8



figure 1.9

Houses on Doctor's Lane have been converted for local retail uses

Churches in King City are both converted as well as retain their original function.



figure 1.10



figure 1.11



figure 1.12

The former GM Dealership site has a opportunity to retain the original building as well as expand the site, building of the unique character of the original building

Two Keele Street properties have been converted to provide speciality retail, however their raised front porches limit accessibility.

# King City - Urban Design Guidelines

## 1.1 Context

King City is a community in transition. Its proximity to Toronto and surrounding GTA, excellent access to Highway 400, GO transit, as well as the introduction of municipal services make the area an increasingly popular community to live, work and visit. It is a village that has been said to have attributes of the city and the country. This diversity is cherished among the residents of the area and is a quality that needs to be preserved throughout the development and growth of the area.

These Urban Design Guidelines concentrate on the village Centre (Community Focus Area - Core Area) of King City as defined in the King City Community Plan dated January 27/2000, Figure 1 - Concept Plan. Five areas within the urban centre have been identified as examples for future mixed-use/residential infill. Given that no one vernacular architectural style or period is dominant in King City, a mix of building types is encouraged in new development. It is anticipated that this approach will not only extend the area's diverse architectural character, but will also assist in meeting the demand for diversity in new retail uses and housing types.

The document examines the existing character and structure of King City's village Centre area; outlines architectural guidelines; identifies potential infill sites; provides a streetscape design for King Road and Keele Street; and lastly makes recommendations for the redevelopment of several key sites.

## 1.2 Objectives

King City's existing buildings, parks and open spaces help provide the basis for the development of the Urban Design Guidelines. The Guidelines are specifically designed to instruct infill and new development within the village's historic centre. Contemporary architectural expressions must be carefully considered for their compatibility to the scale, massing and architectural character of existing buildings.

## 1.3 Guiding Principles

This Urban Design Guideline document provides recommended design concepts that advance a high-quality, integrated approach to enhancing and preserving King City's unique qualities. A fundamental objective for these Guidelines is to guide the development and future growth of the area to ensure that the unique qualities of the area are preserved. The Urban Design Guidelines adhere to the five primary principals outlined below.

1. To Affirm King City's Cultural Legacy
2. To Civilize King City's main streets (King Road and Keele Street)
3. To Establish a vibrant, pedestrian and bicycle friendly Village Centre for the community
4. To Re-define and establish King City's Open Spaces
5. To Foster High-Quality Built Form and Community Design that is Attractive and Economically Vibrant

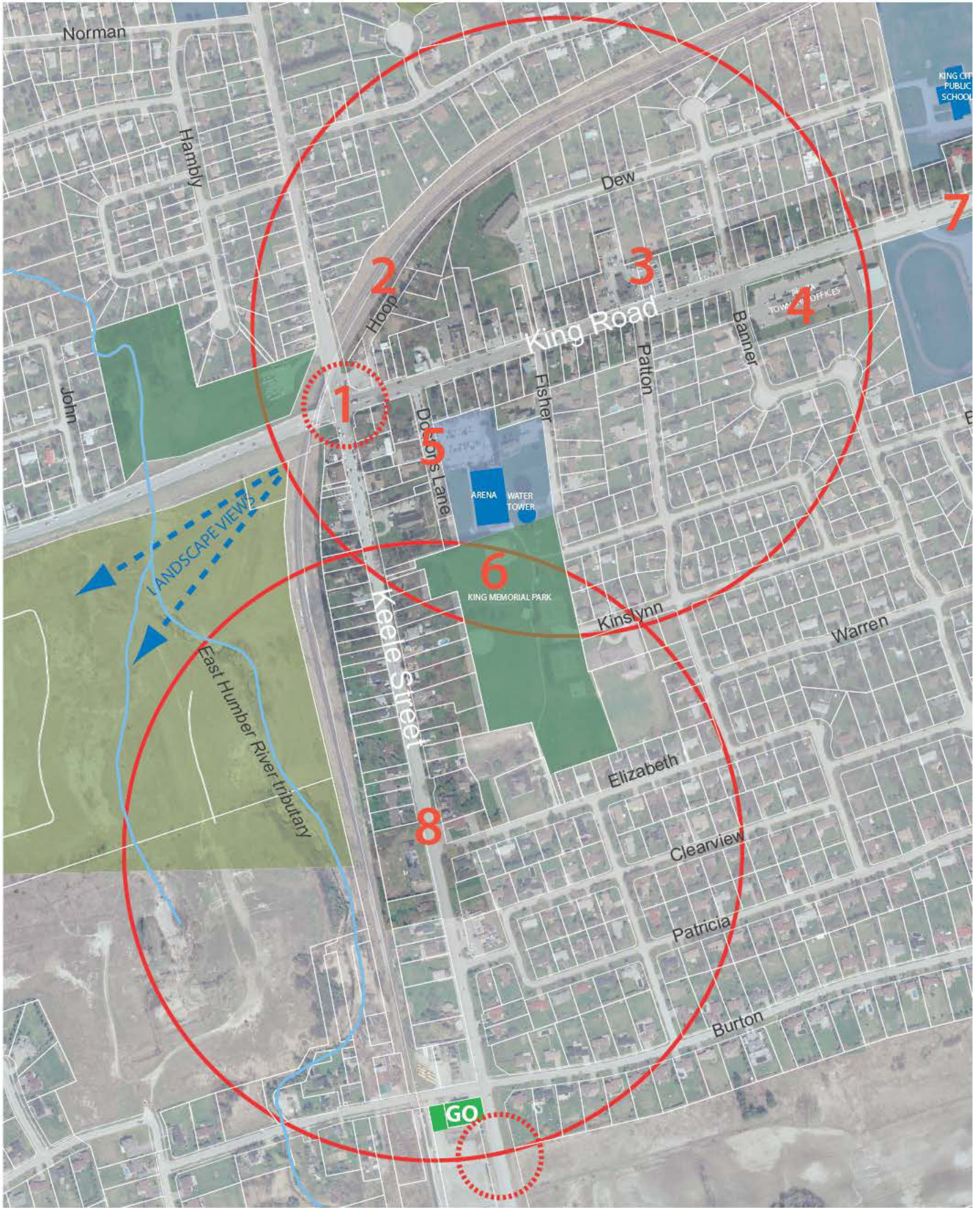



## legend

**1** Keele Street + King Road Gateway

**2** Hoop Street Mews

**3** King Road Infill and redevelopment sites

**4** Township offices + retail mixed-use redevelopment

**5** Doctor's Lane Infill and streetscape enhancements

**6** Arena open space enhancements

**7** King Road street design

**8** Keele Street - street design

 Village Gateway

 Five minute walking radius

 Public Buildings

 Parks

 Open natural spaces

# 3.0 ANALYSIS OF EXISTING CONDITIONS



figure 3.1



figure 3.2

Large truck traffic is a major impediment to pedestrian comfort and safety on King Road

## 3.1.2 street trees

4

For the pedestrian, King Road resembles a highway rather than a village Centre. The proposed design concept limits King Road to four travel lanes (peak hours) and two parking lanes (off peak hour). Future building setbacks and some existing would support regularly planted street trees. The right-of-way can support pedestrian scale lighting, bicycle parking and seating. The combination of these elements would reflect a pedestrian scale village setting. These elements within the right-of-way combined with street parking will provide a physical and acoustic buffer for pedestrians from the traffic.

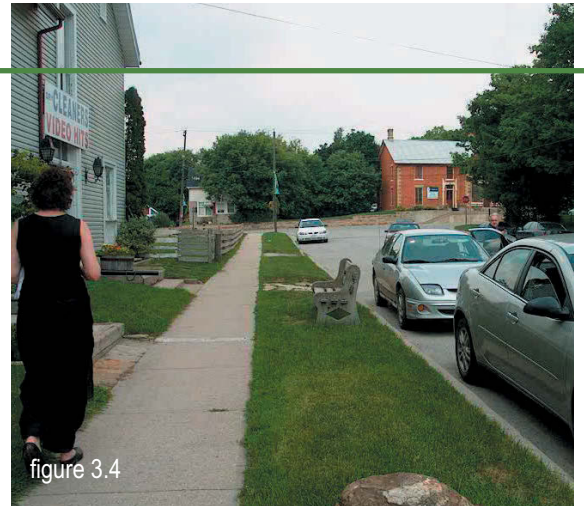

figure 3.4

Street trees are recommended for Doctor's Lane

## 3.1.3 site furniture

Benches, bicycle racks, waste receptacles, and lighting should have a standard form throughout King City's village Centre to unify the area visually, to reduce maintenance and to simplify replacement. A collection of site furniture should be chosen for its durability, its compatibility with the Ontario climate, and its future availability.

Canadian-made site furniture should be chosen for ease of distribution and to ensure that it will withstand Canadian winters.

Colours and materials of site furniture should be coordinated as much as possible. Painted finishes should be avoided; the natural colour of materials will enhance King City's character and minimize long term maintenance.



figure 3.6

Redevelopment will replace existing planters with seasonal high quality landscape treatments



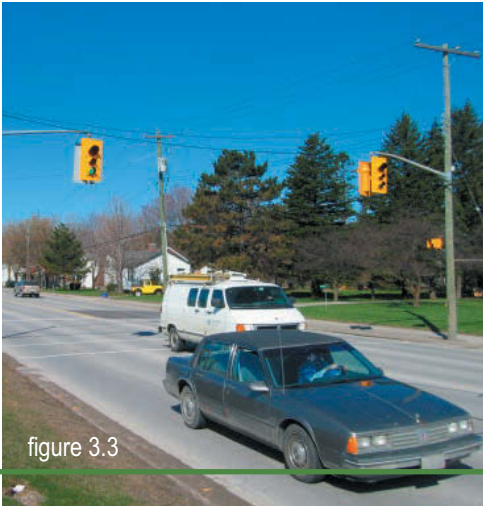

figure 3.3

The following provides a visual analysis of existing open spaces, streetscape and built form conditions in King City. Through a series of open house and workshop discussions with the community of King City, it was agreed that the accommodation of new growth within the Urban Areas must first address the impact of King Road as a high volume road through King City's village Centre. At the same time the community identified other concerns with the existing urban area, a need for more local retail, residential opportunities and access to parks and natural open spaces.

### 3.1.1 traffic



figure 3.5

Large trucks hauling gravel from surrounding pits and heavy commuter traffic passes through the middle of the village and is a constant concern for King City residents. The presence of these trucks on King Road has a significant impact on the quality of the pedestrian atmosphere, making it an unattractive environment for local residents wishing to walk to do errands as well as visitors to the area. In addition to safety issues this condition creates aggressive traffic, emits air and noise pollution.



figure 3.7



figure 3.8

## 3.1 EXISTING AND PROPOSED CONDITIONS: STREETSCAPE



figure 3.9

Double width driveways should be consolidated into one driveway width curb cut to be shared between two properties.



figure 3.10

### 3.1.5 public open space

King City is characterised by expansive views to the surrounding countryside as the village is contained between two tributaries of the East Humber River. The village is well served by parklands with passive and active recreational opportunities as well as access to a continuous recreational trail network. As such, the village has tremendous opportunity to be well connected for walking and recreation.

- 6 King Memorial Park is a well-located open space off of Doctor's Lane and could be further designed to accommodate weekend markets, as well as active and passive recreation. Any proposed structures should be compatible to and complement the Township's Master Recreation Plan.

Wellesley Park is a large park for the residents of King City, however, its lack of direct visibility and location at a busy intersection prevents it from becoming a pedestrian hub. Crossing the busy intersection of King Road and Keele Street is considered to be dangerous for most residents.



figure 3.15

A new mixed-use building at Keele Street provides parking behind using the valley slope.



figure 3.16

A planted buffer would mitigate the appearance of parking beside this pedestrian route.



figure 3.11



figure 3.12

### 3.1.4 driveway curb cuts

To create a cohesive streetscape, the number of and size of curb cuts should be minimized through the use of private laneways or shared driveways. Where possible, driveway access should be paired or consolidated into one, particularly where mixed use, institutional or commercial uses apply.

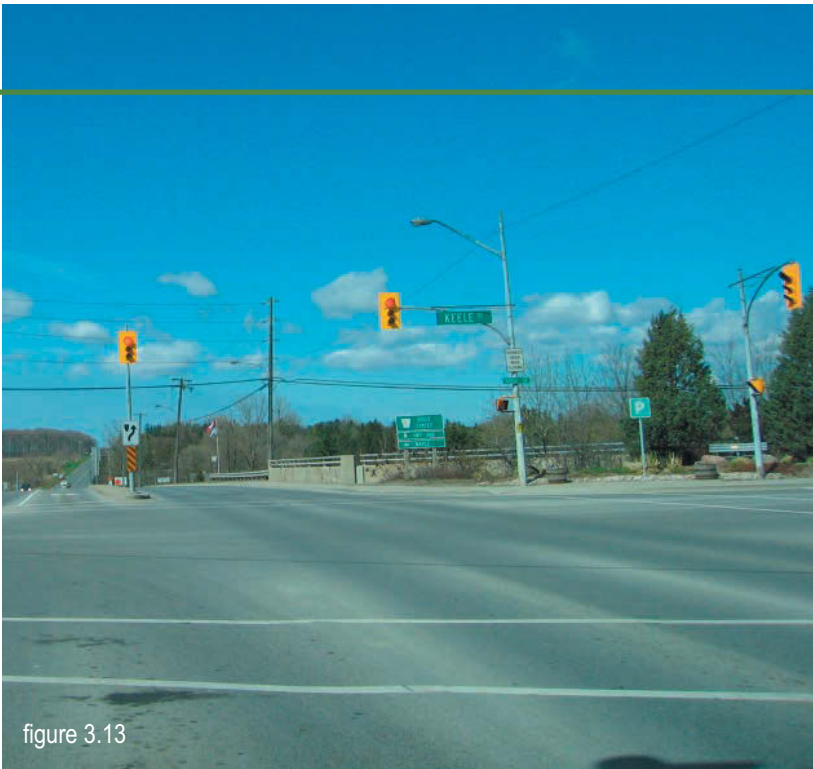

figure 3.13

Keele and King Intersection: primary pedestrian crossings should be replaced with feature paving



figure 3.14



figure 3.19

### 3.1.6 parking

Front yard parking lots should be discouraged. Instead, King Road off-street surface parking should be located between and behind buildings. Street parking on King Road and Keele Street would further extend a conveniently located parking supply with direct access to shops.

Off-street surface parking behind buildings should be linked to adjoining properties and accessed from side streets where possible.

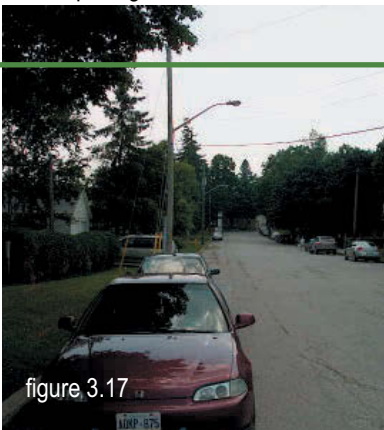

figure 3.17



figure 3.18

## 3.1 EXISTING AND PROPOSED CONDITIONS: STREETSCAPE

### 3.1.7 utility poles

Above ground utilities on both King Road and Keele Street detract from the village's character. Short of burying utilities in the future, the placement of trees and light standards must be coordinated to minimize the visibility of the poles and wires while not interfering with their performance.



figure 3.20 - King Road



figure 3.21 -King Road

### 3.1.8 commercial signage

Cohesive, well designed and high quality signage can immediately improve the village appearance. Mobile and large amounts of back lit signage should be replaced with signs that have a hand crafted appearance, are not oversized, and are free standing or well integrated with the building façade.



figure 3.23

A positive example of signage that is designed for both pedestrian and vehicular traffic.



figure 3.24

There is a lack of pedestrian access to the Plaza where the Township Offices are located.

8

### 3.1.10 pedestrian safety

King City's Village Centre is a hostile pedestrian environment. Street calming techniques such as tree planting, boulevards, on-street parking, textured paving and clear pedestrian zones help to slow traffic to create a safer pedestrian experience.



figure 3.27

Many residents use the informal pathway through the Anglican Church grounds to avoid the intersection of King Road and Keele Street.

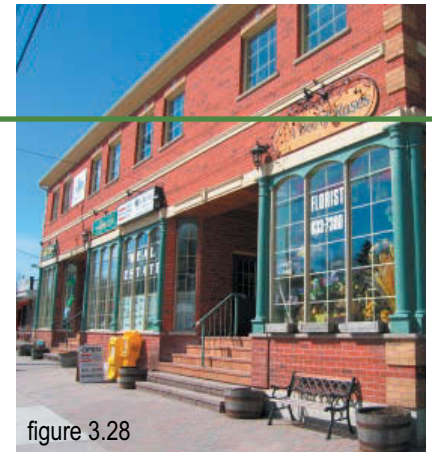

figure 3.28

Universal accessibility is also a pedestrian safety issue; all new buildings should have their main floor at grade.



### 3.1.11 Servicing

All building service areas should be located away from public view at the side or rear of buildings.

figure 3.22



### 3.1.9 pedestrian paving

A palette of different paving materials can define pedestrian routes to make the pedestrian experience safer along King Road. Buffered sidewalks, crosswalks marked with bands of unit pavers, and boulevards that signal pedestrian rest stops create safe and pleasant pedestrian streets.

figure 3.25



figure 3.26

Contrasting unit pavers would define the pedestrian crossing area and alert drivers to stop.

The pedestrian zone on King Road is directly adjacent to traffic.



figure 3.29

Pedestrians must walk directly next to heavy vehicular traffic on King Road.



figure 3.30

Pedestrian and vehicular zones are unclear.

## 3.1 EXISTING AND PROPOSED CONDITIONS: STREETSCAPE



figure 3.31



figure 3.32

### 3.2.1 residential building typology

King City began as a residential community at the crossroads of King Road and Keele Street with a few original retail buildings and local amenities. Over time, houses have converted to retail/office use or were replaced with generally suburban development pushed back from the street with parking in the front yards (i.e. Township Office, Country Style Donuts). The resulting well-spaced built form in the village Centre is atypical of many Ontario Main Streets which were built with a more continuous building frontage. While this non continuous building frontage should be respected and retained in existing buildings, we recommend that some infill that include more continuous retail frontages with several shops be introduced at strategic infill locations including the Keele Street/King Road intersection, the former GM Dealership Site and the existing Township Office site.

10



figure 3.36



figure 3.37

Pedestrian and vehicular zones are unclear.

### 3.2.4 front yard parking

Off-street surface parking areas fronting on to King Road and Keele Street undermine the street edge and opportunities to create a vital pedestrian scale environment. By planning parking to the side or rear, buildings can have direct street frontage and where front yards setbacks apply; these areas can include landscaping, gardens or other features. Intersections in particular can be designed to become informal gateways into the retail area.

### 3.2.2 a diverse mix of old and new

King City has a diversity of architectural styles, combination of construction techniques and buildings materials that represents the areas historic quality. Brick, stone wood and some stucco are the main material palette and should be used for contemporary development for their quality durability and historic appropriateness.



figure 3.33



figure 3.34



figure 3.35

### 3.2.3 new construction

New buildings in King City should reflect the historic qualities of the village through their scale and architectural form. Buildings in King City are generally, two to three storeys in height with pitched roofs and have well detailed dormers, gables, windows, eaves and front entrances. New buildings should be compatibly designed to reflect, but not necessarily mimic, these proportions and detailing. Similar building heights of a minimum two to three storeys should be maintained. On limited special sites where higher densities may be desired, (i.e. Township Office Site, King and Keele intersection) additional storeys may be considered but will require an Official Plan Ammendment.



figure 3.38



figure 3.39

The library should have improved pedestrian access to the school across the street.

## 3.2 EXISTING AND PROPOSED CONDITIONS: BUILT FORM



figure 3.40



figure 3.41

### 3.3.3 new construction

Each new building should take advantage of its specific urban condition. Buildings located at corners should create facades on both streets. New residential construction can vary in form to provide different residential choices for the community.

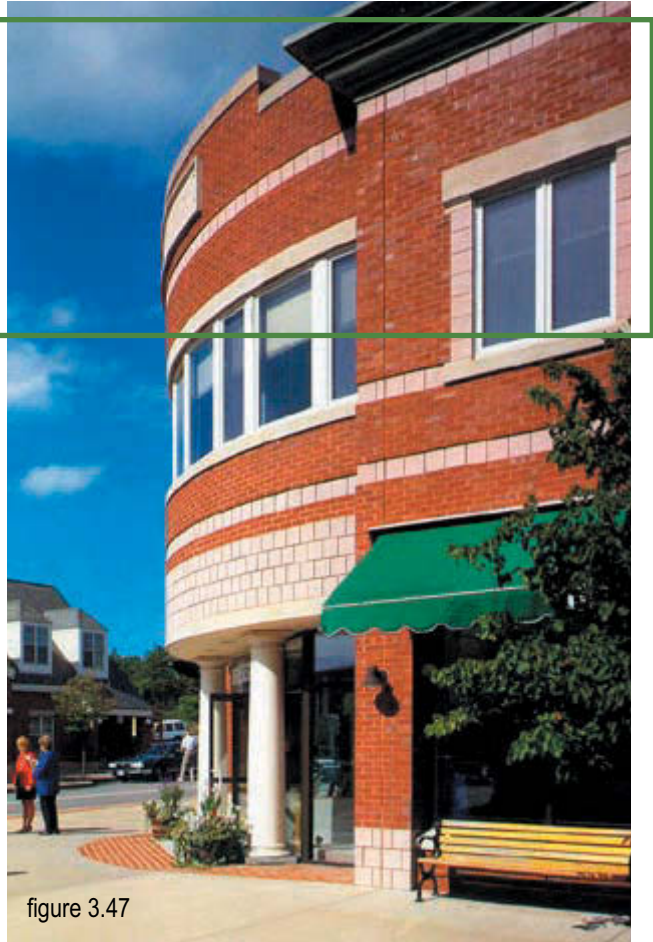

figure 3.45



figure 3.46

figure 3.47



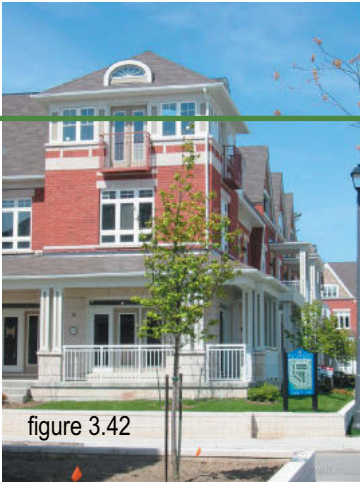

figure 3.42

### 3.3.1 street sections

Locating buildings close to the street is an important step to create a dynamic urban environment. A comfortable pedestrian environment is created through a combination of continuous building facades, street trees, and street furniture.



figure 3.44

### 3.3.2 architectural detailing

The use of architectural details and materials that reflect what is historically evident in the village ensures that new buildings will complement the existing. An architectural richness can be achieved in all new buildings when there is an attention to scale and proportion.



figure 3.43

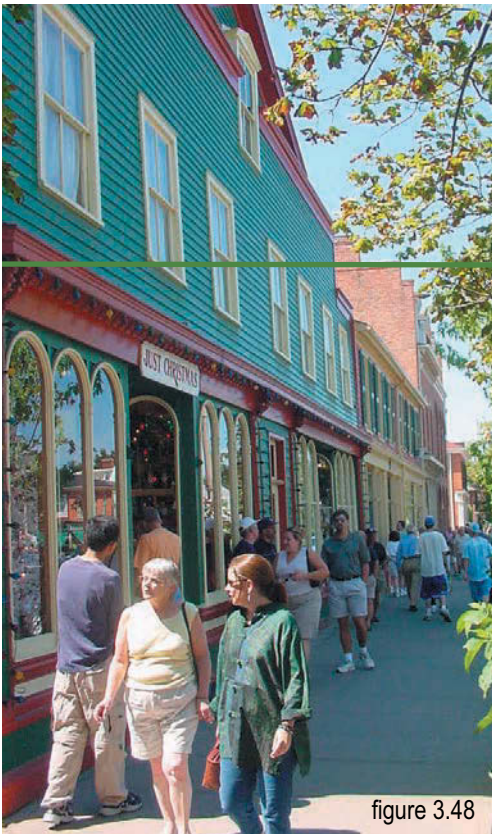

figure 3.48

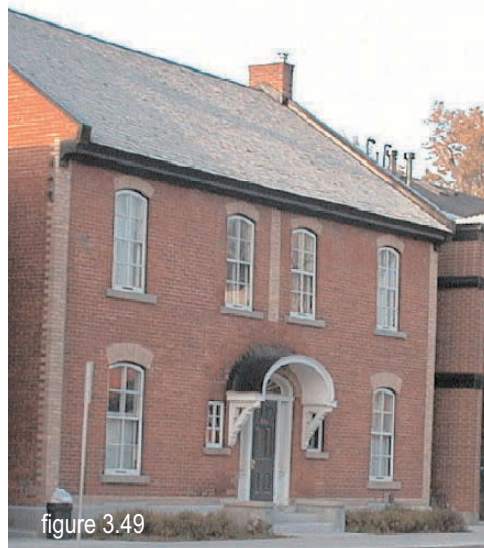

figure 3.49

### 3.3.4 building typologies

Mixed-use developments can encourage vibrant streetscapes where activities extends throughout the day and evening.

New developments should highlight elements of historic buildings through the use of compatible building forms, window proportions, roof lines and materials.

## 4.0 Urban Design Guidelines: Goals

King City's Urban Design Guidelines are intended to promote a visually rich building fabric that projects a distinct neighbourhood image through the use of materials, building form, site planning and architectural styles.

Existing King City buildings are representative of rural Ontario architecture. While styles, materials and details differ, a general similarity exists in the architectural massing and shape. New construction should complement the existing low-rise, generally residential form urban fabric but should also support the community's transition into a more vibrant, pedestrian supportive urban environment.

## 4.1 General Recommendations

- a** Architectural styles should be varied to maintain King City's diverse urban fabric but relate contextually in form and scale. Despite the use of various architectural styles, quality should be consistent and building materials and finishes should reflect a high level of craftsmanship.
- b** While creativity and innovation should not be stifled, the architectural language of new construction may attempt to emulate past styles, or provide contemporary expressions which are compatible with the scale, massing and details required to support King City as a vibrant urban community.
- c** Consistent rhythms of similar, not identical, details and architectural elements should be used to establish the continuity of the street facade and assist in the creation of a strong neighbourhood image. The existing topography should be respected, acknowledging the importance of maintaining strategic views between buildings and the inherent spacious quality of the original village fabric.
- d** The use of high quality building materials including stone, wood, metal and concrete is highly recommended.

14

## 4.2 Public Realm

### 4.2.1 Gateways

A sense of arrival to King City should be reinforced by the built form, landscape and enhanced treatments aligning the street. Therefore, we do not suggest using free standing gateway markers to mark arrival to the Village Centre. The western entry should be marked by built form and parkland facing the intersection. The eastern entry should be marked by a double row of street trees on both sides of King Road at the school and library frontages. In the longer term, the King



Figure 4.1 Pedestrian friendly zones are constructed from a series of elements such as planting, building massing, sidewalk widths, retail at grade, etc.



Figure 4.2 New, more compact building typologies would provide housing choice for the community.



Figure 4.3 A double row of street trees form the initial gateway into the eastern edge of the village on King Road

Township office site will form a strong sense of arrival to the Village Centre through street oriented buildings which should include a combination of retail at grade in addition to the potential Township Offices or residential/office uses.

## 4.2.2 Above Grade Utilities

Utility wires have a negative impact on the urban environment. Wherever wires can not be buried special care must be taken in the location of plantings to mitigate but not interfere with the overhead wires. When upgrades take place efforts should be made to consolidate wiring, effectively eliminating excess poles which lead to street clutter and can interfere with pedestrian travel and mature tree growth.

## 4.2.3 Traffic Mitigation

To reclaim the busy roads of King Road and Keele Street for the pedestrian the following overall traffic mitigation techniques are recommended.

- Contrasting and textured concrete or brick paving should be used to signal to motorists to slow down and show pedestrians where to cross.
- Road narrowing, on-street parking, street tree planting, and sidewalk widening should also be used, where possible.
- All buildings should front onto streets to further contribute to an active street edge that serves to calm traffic.

## 4.2.4 Parking and Curb Cuts

Non-peak hour street parking should be introduced on both Keele Street and King Road. The positive effects of allowing street parking are both economic and urban: improved access to local business has the opportunity to increase in village spending. By effectively narrowing the transit road through-out the village, traffic is encouraged to slow down, helping to civilize the streets for pedestrians.

- Parking lots in front of shops should be discouraged as they enforce a streetscape that is dominated by wide expanses of cars and asphalt.
- Providing parking at the rear of main street buildings enables sidewalks, street trees and building facades to establish a defined street edge. This is a principal requirement for creating vibrant urban streetscapes in King City.
- A centralized municipal lot is recommended with a reduction of on site parking requirements for new developments, this could be located at the Hoop Street Mews or throughout redevelopments on deep lots north of King Road.
- Adequate parking facilities should be provided in the village centre to minimize traffic infiltration into neighbouring residential areas.

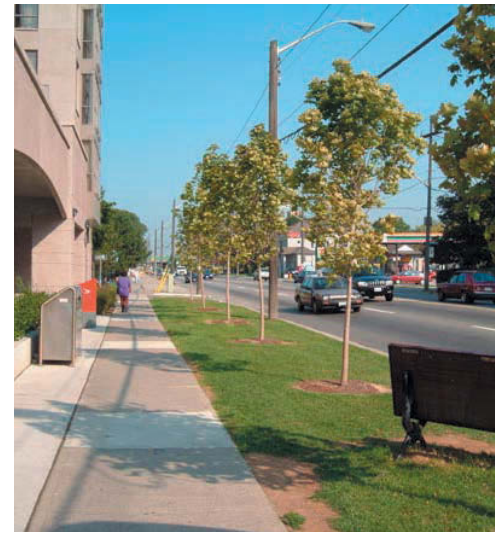

Figure 4.4 Offsetting tree planting from wires can help mitigate the visual impacts of overhead wiring.

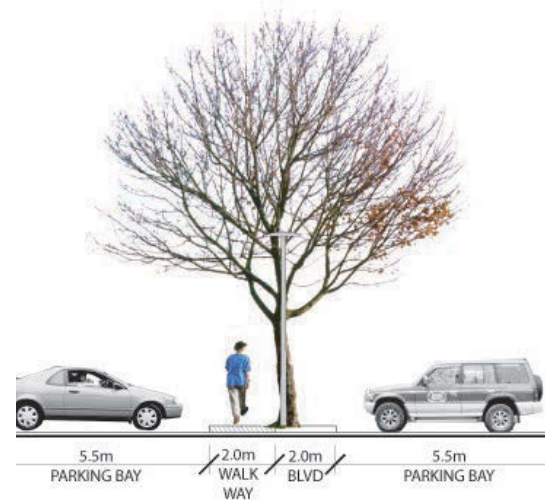

Figure 4.5 Clearly identifying pedestrian zones aids in the functionality of parking lot layouts



Figure 4.6 Greening parking lots with trees and planting minimizes the visibility of asphalt.

Minimizing the number and size of curb cuts where possible is an important step in reclaiming a street for pedestrians. Each interruption in the sidewalk diminishes a pedestrian's walking experience and feeling of safety.

- The number of curb cuts should be minimized through the use of private laneways or shared driveways, new curb cuts for residential laneway or driveway should not be wider than 3.5 unless the additional width can be justified at Site Plan Approval.
- Where appropriate, driveway access should be paired or consolidated into one, particularly where providing access to rear parking lots for mixed use, institutional or commercial uses.
- Parking areas for abutting commercial uses should be connected.
- Wherever possible consolidated parking areas should be accessed from side streets to minimize curb cuts on main roads.

## 4.2.5 planting

Plant material should be chosen for its ability to withstand the climate of King Township, for its visual interest throughout the year, and for ease of maintenance. Intricate planting patterns should be avoided. The preferred method is to use masses of low-maintenance plants placed at key locations to direct pedestrian traffic, screen parking lots and provide visual interest. Simplicity of plant character in keeping with the architectural palette will create a unified composition properly scaled to the width and heritage character of the street.

- Low maintenance planters and planting areas should be used at the street edge to soften hard surfaces, i.e. parking lots. Plantings should be used to announce entrances, to accent open space areas and define walkways.

## 4.2.6 lighting

The location and style of light standards impacts the visual quality and usability of any streetscape. It is important that a style is chosen that reflects the architectural and heritage quality of King City. Welcoming atmospheres can be created by introducing pedestrian-scaled lighting which enhances safety, casual strolls and lingering.

- As a minimum, pedestrian-scaled lighting should be provided on the main streets of Keele Street and King Road. Lighting should also be provided adjacent to parks, public open space, pedestrian walkways and institutional or commercial areas.
- Light standards may be outfitted with banners to enhance the seasonal atmosphere of the area.
- Light standards should be chosen for their longevity, quality of materials, resilience to Canadian winters and use of de-icing salt as well as for style, scale, and lighting measures. Ideally, street lighting should be down cast to minimize light pollution.
- Cut-off lighting should be used to minimize light spillage into the atmosphere.

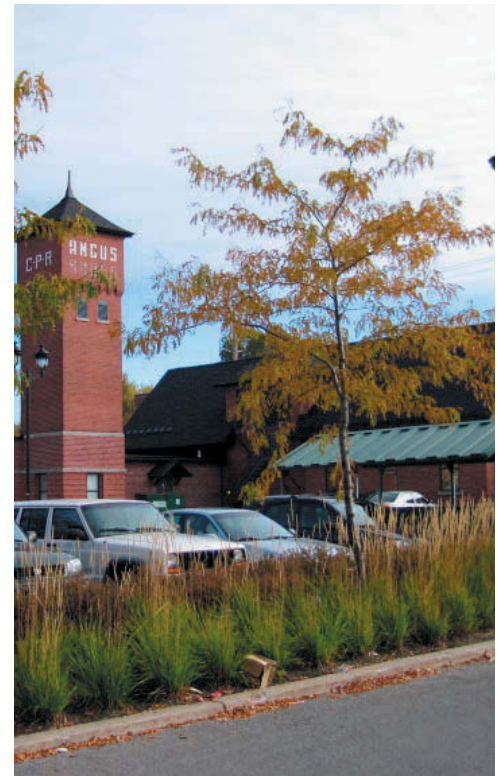

Figure 4.7 Planters with vertical elements should be installed to buffer existing street fronting parking lots from the sidewalk



Figure 4.8 Pedestrian-scaled lighting should have a heritage character throughout the Village Centre.

## 4.2.7 street furniture

Benches, bicycle racks and waste receptacles should be standardized throughout the Village Centre to visually unify the area, reduce maintenance and simplify replacement.

- A collection of street furniture should be selected for its durability, its compatibility with the King Township climate, and its availability for additional purchases in the future.
- Canadian-made street furniture should be chosen for ease of distribution and to ensure that it will withstand Canadian winters.
- Colours and materials of site furniture should be coordinated as much as possible.
- Furniture styles should be complementary and consistent.
- Street furniture should be placed out of the way of emergency and maintenance vehicles, especially snow removal vehicles.
- Bicycle racks should be installed at regular intervals throughout the downtown.



Figure 4.9 Standard, galvanized bicycle racks should be installed in the Village Centre in areas where a wider sidewalk can be accommodated, at parks and public gathering areas such as the Library, the schools and the Township Offices.

## 4.2.8 street trees

A tree canopy is integral to the design of King City's streetscaping plan, and is fundamental to the image and quality of life in the core area. Trees provide positive modification to our climate, help to diminish water and air pollution, and provide a desirable pedestrian environment. Street trees not only create beautiful, light-dappled pedestrian areas, but they also help calm traffic.

- Any new construction should preserve existing mature trees and woodlots to make them features of the community.
- Native street trees should be planted throughout the village, especially along both edges King Road and Keele Street.
- Tree pits should be constructed using a connected trench method to provide optimal growing conditions, ensuring regulation of moisture levels, and maximum room for root growth.
- Only native species that are tolerant of urban conditions, salt, poor soil, and uneven irrigation, should be planted. Good examples are Silver Maple, Red Maple, Red Oak, and White Oak.
- To ensure that trees do not suffer from soil compaction that restricts water and air around their roots, the bases of trees should be planted with groundcover or shrubs and mulch, or metal tree grates for intensely used areas.
- Adjustable tree grates that allow for growth of the tree should be used. Gravel should be filled under the tree grate to prevent debris from accumulating between it and the finished planted grade.



Figure 4.10 Street trees play a key role in establishing pedestrian friendly and inviting streetscapes

## 4.2.9 sidewalks and planters

Pedestrian friendly sidewalks are important for King Road and Keele Street. To realize a walkable street, pedestrians need to be given a clearly demarcated, continuous zone that is protected from vehicular traffic. The use of strategically placed planters in the sidewalk between the pedestrians and vehicles gives the pedestrian an added sense of security. By interspersing the planters with hard-scaping, areas are provided for bike racks and street furniture that will not impede pedestrian travel.

- Continuous sidewalks should be constructed in either poured in place concrete with a broom finish for traction and/or brick pavers.
- A continuous public sidewalk should be provided on both sides of arterial roads.
- Sidewalks are recommended to be a minimum of 1.5 metres in width. Wider sidewalks (2.0 metres minimum) adjacent to shops, institutions and public paths should be considered.
- Sidewalks should be typically concrete and/or brick pavers and should be continuous across driveways. Where crossings over driveways and intersections occur, sidewalks should be marked through other materials such as brick pavers.
- Sidewalk edges and curbs should be graded and scored to provide barrier-free access for people physically and visually impaired.



Figure 4.11 Sidewalk widening provide room for pedestrian amenities like planting, seating and seasonal café space.



Figure 4.12 Textured pavers should mark Village Centre intersection.

18

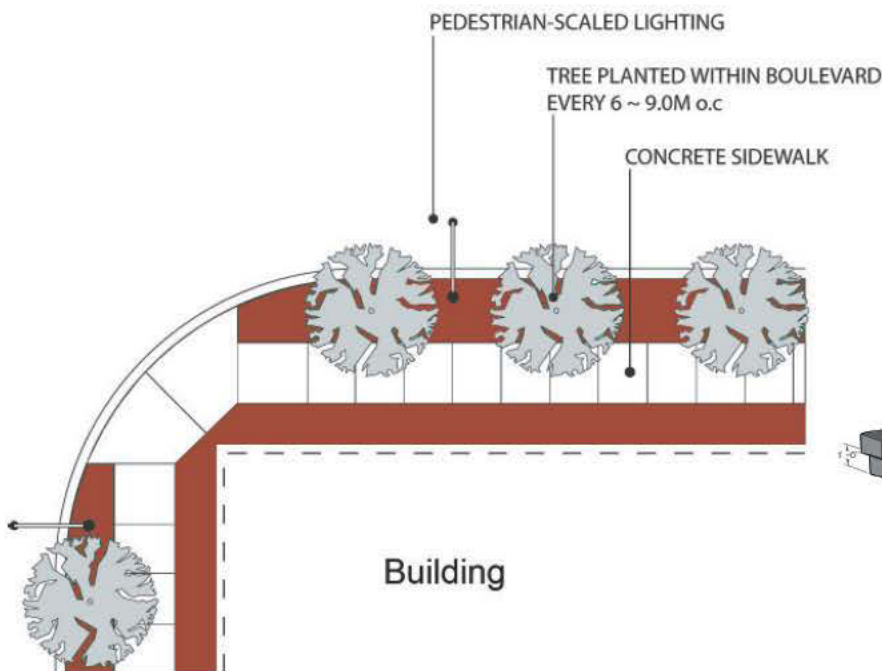

Figure 4.13 A potential corner plan that incorporates site details to enhance the pedestrian experience.



Figure 4.14 Diagram of a potential Planter/Seat Design for an Amenity Zone

## 4.3 Private Realm

### 4.3.1 massing

Massing refers to the size, scale and shape of a building. By ensuring that the massing of new construction adheres to these guidelines many reurbanization goals can be achieved. These goals include creating vibrant streetscapes, minimizing existing and eliminating new parking lots at the street edge and reflecting existing architectural styles.

- All new construction on King Road and Keele St. should be no less the two storeys in height.
- Maximum building heights should generally not exceed 3 storeys unless a building proposal demonstrates that additional storeys can have compatible scale and massing with neighbouring properties.
- On sites where a third storey is deemed suitable, the upper floor can be contained within gables and pitched roofs to reflect the architecture vernacular of King City.
- In locations where more than two storeys are proposed the upper floors should be setback from the street and adjacent buildings to minimize the appearance of height.
- On continuous building frontages, the building façade should be generally divided into individual storefronts or entrances.
- Roof lines for infill development should match in style or complement preexisting heritage roof lines.
- Large bay windows with a high proportion of facade glazing is recommended for ground floor retail, glazing on upper floor should match or exceed (+20% maximum) the proportion of glazing found in adjacent buildings.
- On sites that are wider than they are deep, street frontage should be developed as a row of individual stores, or at the very least, project the appearance of multiple shops.
- Storefront design should be designed to establish a rhythm of a heritage storefront character with recessed entries, porches, awnings and/or large bay windows.
- Residential apartments above street level shops should be encouraged as this use contributes to increased street animation.
- Rear façades should also be created, upgraded and maintained as storefronts, especially where there is an opportunity to create active retail space, e.g. back-of-lot café, or restaurant patios, etc.
- Commercial units should be accessed at grade.



Figure 4.15 The use of high quality building materials will reflect the historic styles of King City village



Figure 4.16 Buildings located on corners should have frontages on both streets

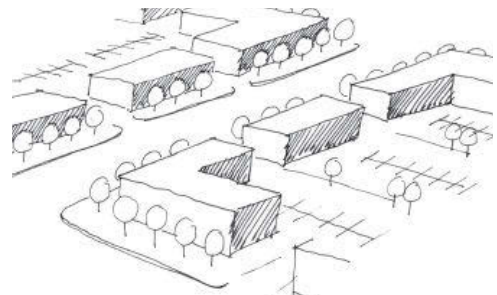

Figure 4.17 New building should have parking behind with the building face at the sidewalk

### 4.3.2 new construction addition and renovations

The appearance of new construction will have a major impact on the long term visual quality of King City. A balance must be achieved in new construction that does not prevent the incorporation of new architectural styles but guarantees a quality of construction that enhances the diversity of styles that already exist in the area.

- Details such as porches, chimneys, eaves, gables, cornices, and the way materials are combined reinforce a building's style. On existing buildings, these details should be preserved and restored. On new buildings, care should be taken to finish buildings using the same level of detail.
- Additions to an existing building should reference the building to which it is being added both volumetrically and materially.
- Special consideration should be given to match existing roof lines.
- When adding structure to an existing building, particularly a heritage structure, care should be taken to match materials used in the original building in colour, texture and type.
- While elements and details that are true to the building should be introduced, the distinction between old and new should not be obvious to the casual observer.
- Existing buildings should not be altered through embellishment or other decorative means against their initial stylistic intent.



Figure 4.18 A variety of façades contribute to a common setback.

20

### 4.3.3 setbacks

Currently in King City the predominant building type found on the main streets are of a residential style with large front yard setbacks. More recently constructed commercial/office buildings are typically only single storey and are also set back from the street to allow for parking in the front yard.

- All new construction should balance these large setbacks by location building faces in close proximity to the sidewalk, all dedicated parking will be located behind new buildings and additions.
- Some provision can be made for planting boxes or small green spaces in front of new buildings reflect the areas rural farming community quality. These green spaces should be no wider than 5 meters and should not in any way anticipate the location of additional parking spaces in front of buildings.
- Maintain a degree of spaciousness between buildings and property lines.



Figure 4.19 Buildings can frame public spaces at key intersections.



- A minimum 2m wide barrier free walkway should be provided between a single unit doorway and the sidewalk.
- A minimum 3m walkway should be provided to all multiple unit doorways and the sidewalk.
- If possible existing parking lots in front of buildings should be converted into green spaces, relocating the parking to the back of the buildings.

### 4.3.4 rooflines

The roofline of any new buildings can be as diverse as the types that already exist in King City. Attention to the rooflines of new buildings and the relationship to adjacent buildings will help infill the downtown with appropriately detailed and styled new construction.

- A variety of rooflines and shapes should occur in each block.
- Roof forms should apply a generally consistent roofline in mass to other buildings in the village.
- Roof materials and colours should complement the building materials and the proposed building design.
- Sloped roofs should have a minimum slope of 30 degrees to effectively shed snow loads.
- Townhouse and multiplex dwellings should express individuality of address through defined roof forms that express separate dwellings and contribute to a residential character for the overall development.
- Roof elements including chimneys, dormers, pitches, cupolas, and vents should be incorporated as distinct elements providing the potential for additional variety in the image of one dwelling to the next.
- The use of dormers on sloped roofs is encouraged to ensure livability in top storeys, or to allow future conversion of attic spaces. Dormer windows should be of the same type and proportion as those used for windows in the lower storeys.
- Where ever possible green roofs should be incorporated into the design of flat roofs. Examples of green roofs can include roof top gardens with patios or sod roofs



Figure 4.20 Peak roofs are the typical of King City



Figure 4.21 Many different roof styles are found in the area



Figure 4.22 Peak roofs are recommended to mitigate additional building heights above the existing 2-3 storey urban fabric

## 4.3.5 architectural detail

The choice of elements and details should reflect architectural characteristics associated with King City as set out in the following sections. These characteristics can be applied as pure representations or combined with one another to create hybrid interpretations of the village vernacular.

## 4.3.6 entranceway

Building projections including porches, decks and canopies are encouraged as transitional building elements that provide weather protection, dwelling access and active amenity spaces. Entrances in King City typically include elevated and at-grade porches.

- To ensure fully accessible buildings a grade entry should be maintained or established, if possible a deck, porch or canopy should be included in new construction.

## 4.3.7 signage

It is essential that businesses within the Downtown area are able to identify themselves through individually distinct and recognizable signage. At the same time it is also important that the quality, scale and style of signage be reflective of the architectural styles of the area.

- Signage, banners, interpretive signs and plaques should be used to capture the identity of the village and generate excitement among residents and visitors.
- Signs should be made from natural materials; back-lit fluorescent and plastic signs should be avoided. Apart from their poor fit with the façade, they do not reinforce the Village Centre as a pedestrian-scaled main street.
- Architectural signs marking historical dates and names should



Figure 4.23 At grade entranceways with overhangs are recommended



Figure 4.24 Different buildings styles can be incorporated if they adhere to the requirements of the Guidelines through massing and materiality

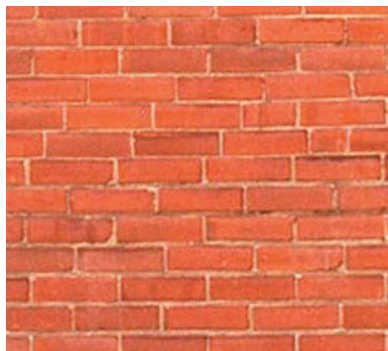

Figure 4.25 Red brick is a primary construction material for King City



Figure 4.26 Stone is a recommended high quality construction material that is also recommended



Figure 4.27 Brick detailing adds interest to a facade

be integrated into the building fabric and constructed from cast metal, stone or tile.

- Commercial signs should be scaled and designed for both pedestrians and motorists.
- Back-lit fluorescent signs should be avoided.
- Signs should enhance the architectural character of the building façade; the building should be assessed to determine what types of signs are appropriate within its frame.
- If a building is a heritage structure, historical photographs should be consulted to establish the types and styles of signs appropriate to it.
- A historically themed sign strategy for all public streets, buildings, parks, trails, watercourses, woodlots, gateways and other facilities should be adopted for the entire community.

### 4.3.8 fences

There is a great variety of fence types found in the Township of King: wood picket, cast iron, traditional agricultural and living fences, i.e. hedges. They all have an approximate height of three feet and are made of natural materials. These fences can provide an important vertical element at the street edge.

- New fences are encouraged and should echo the character of existing village fences in terms of materials, visual permeability, and height. Fences along on main streets are encouraged to aid in establishing a firm street boundary.
- Use of landscaping and fencing should be utilized to buffer neighbouring residential neighbourhoods from new developments.

### 4.3.9 building materials

Part of the character of King City's architecture is due to the natural local building materials used in construction: red brick, yellow brick, stone, painted and natural wood siding. These high-quality materials should be used in new construction, both commercial and residential, to knit the new buildings to the existing village and give King City a unified character. The tradition of building with a wide variety of natural materials should be continued so that new development is linked to the existing village without necessarily replicating styles and design.



Figure 4.28 Using traditional fencing styles maintains an authentic village feel - wood split rail fence.



Figure 4.29 The existing stone wall on King Road is a wonderful means of transitions heights. A more durable natural stone retaining wall product should be used to maintain the look and feel of the original wall in the event it needs to be replaced.

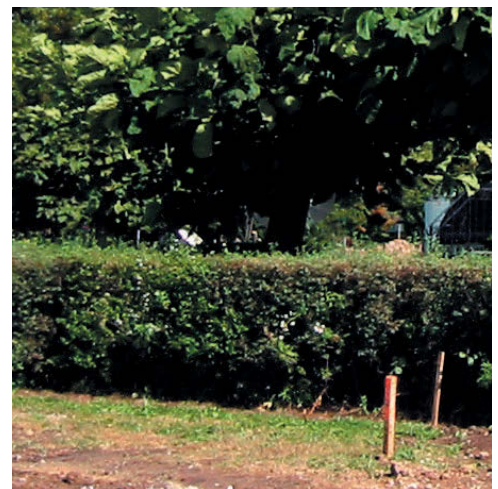

Figure 4.30 Living fences like hedges and bushes help to articulate private and public spaces

# 5.0 Proposed Streetscape Design

King Road is recommended to retain its existing right-of-way within which the following urban design guidelines should apply.

- Maintain 4 lanes for traffic, and permit off peak street parking on the outside lanes.
- A minimum 3 meter sidewalk and boulevard area should be provided between the curb and extent of the right-of-way to permit a minimum 1.5m sidewalk and a 1.5m boulevard.
- The boulevard should contain hydro poles, lighting (street and pedestrian scale), and attraction banners.

The township should continue to pursue a widening of the right-of-way through site plan approval. This additional width of 2.5m should be finished in the same broom finished concrete as the sidewalk.

- The programming for the amenity areas should always include a tree in a tree pit and a bench. Additional street accessories for these areas could include a garbage can or bicycle rack.
- Newspaper boxes should always be consolidated at corners.

24

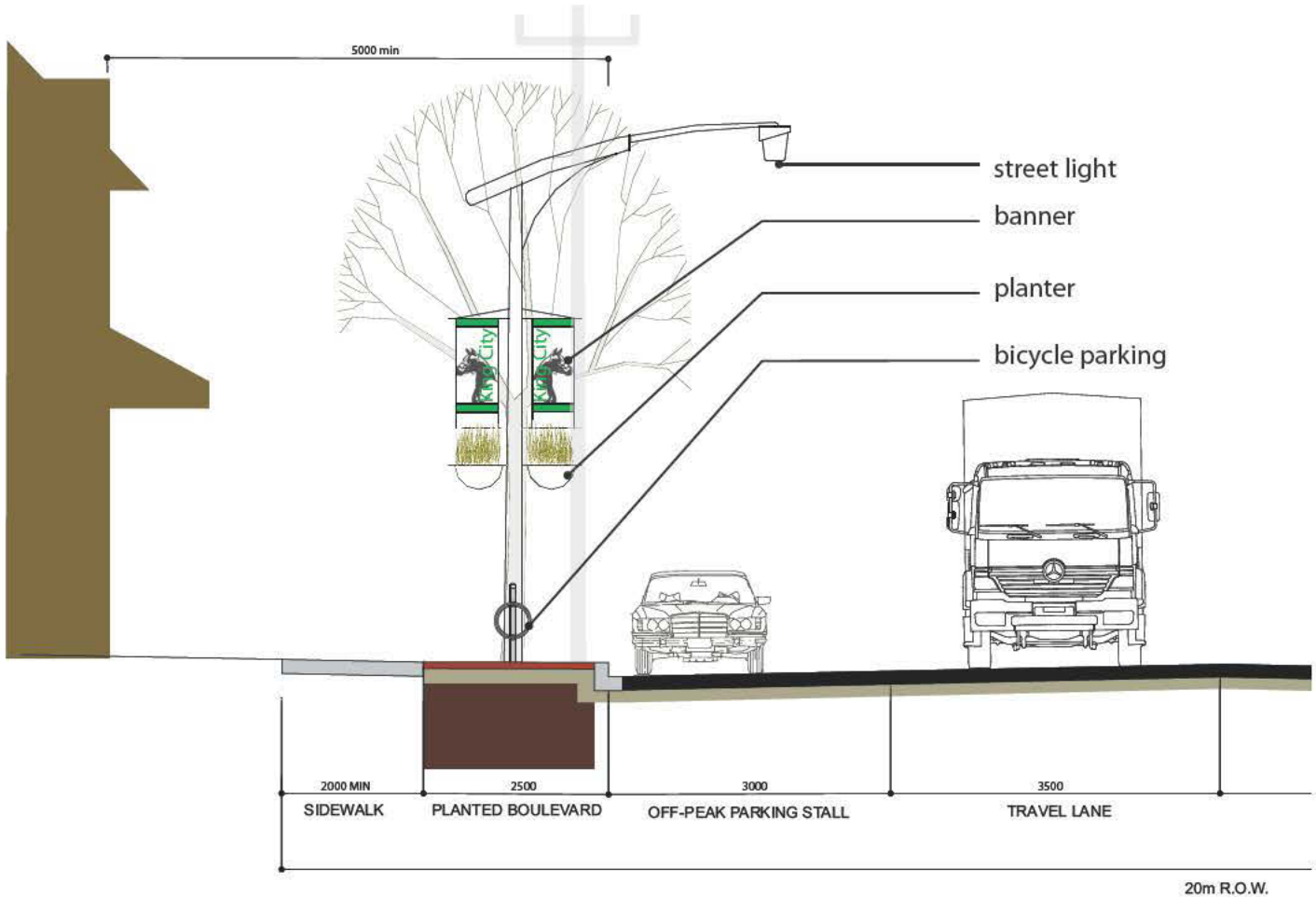

FIGURE 5.1 - PROPOSED SECTION AT BLOCK REDEVELOPMENT AREAS

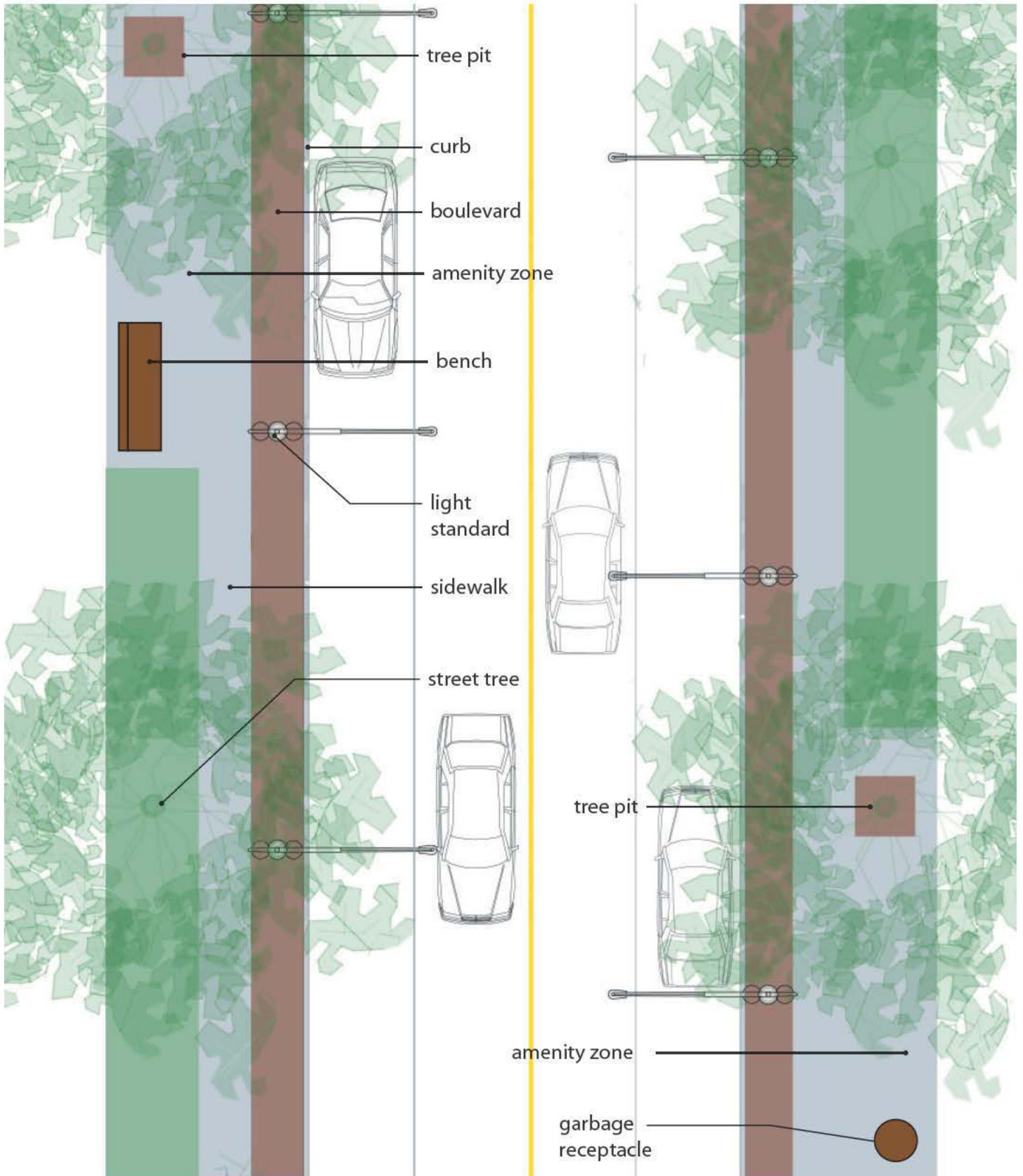

FIGURE 5.2- PROPOSED PLAN DETAIL

## 5.1 TYPICAL ROAD SECTION: KING ROAD



FIGURE 5.3 - EXISTING SECTION

26

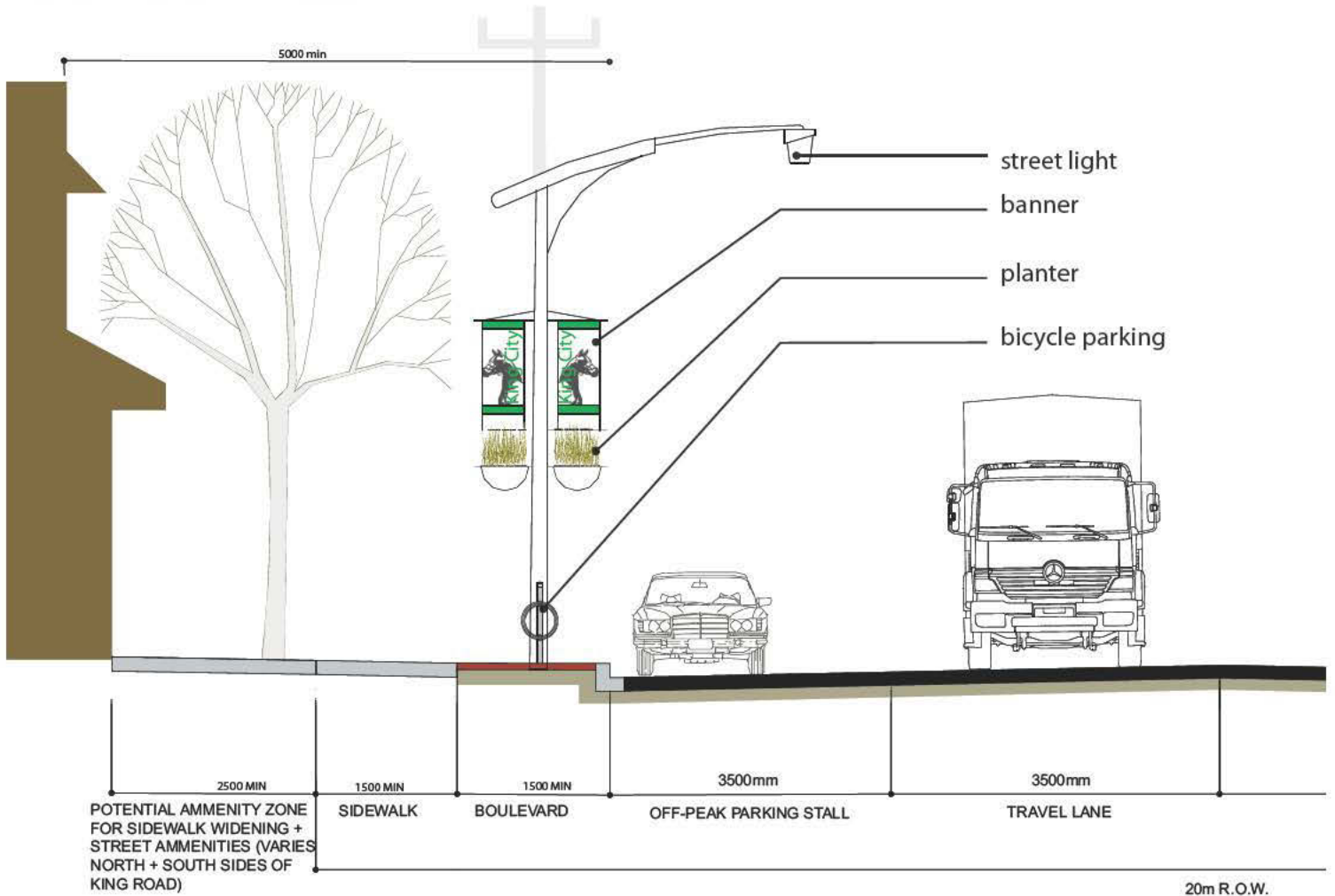
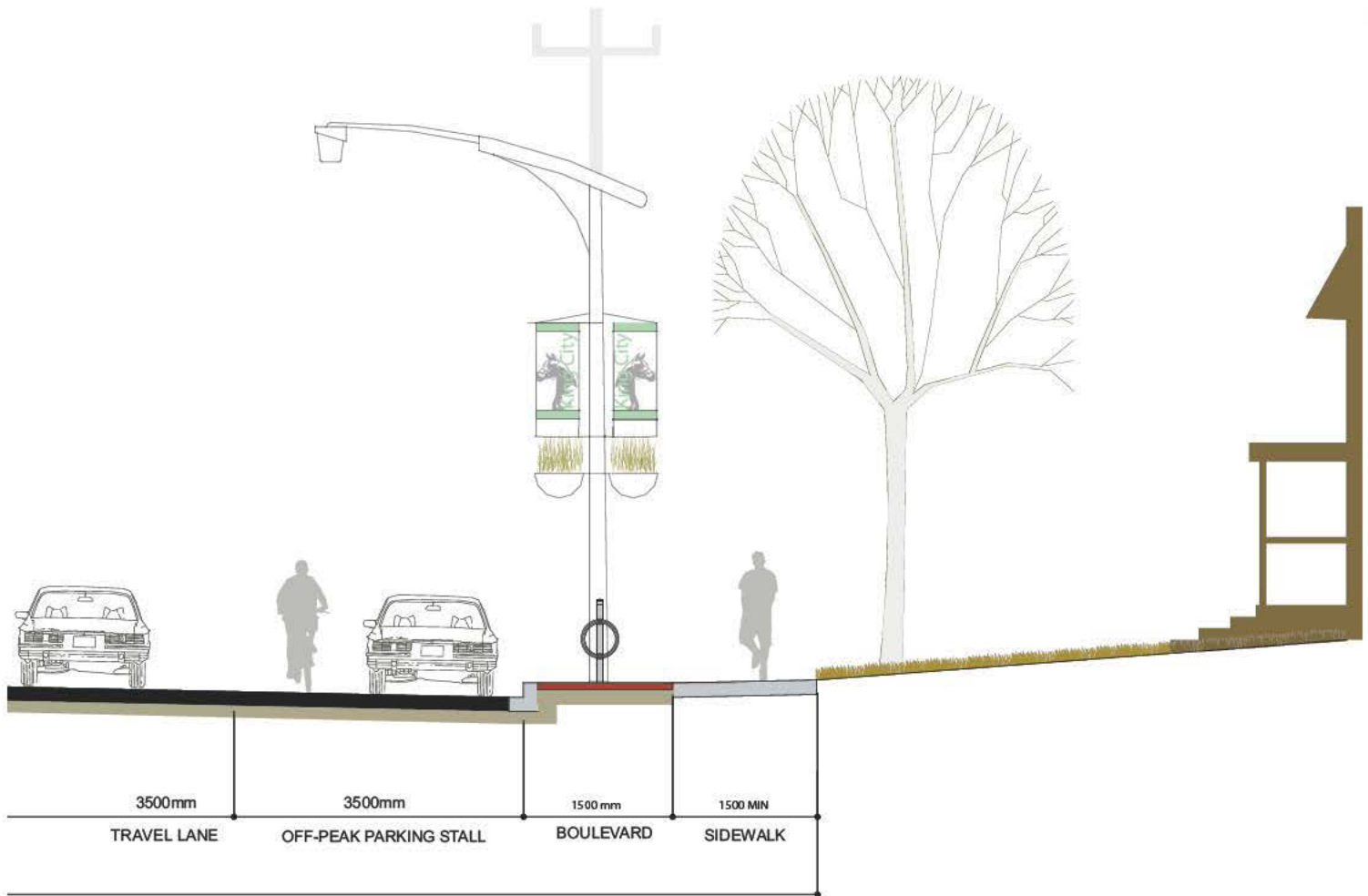
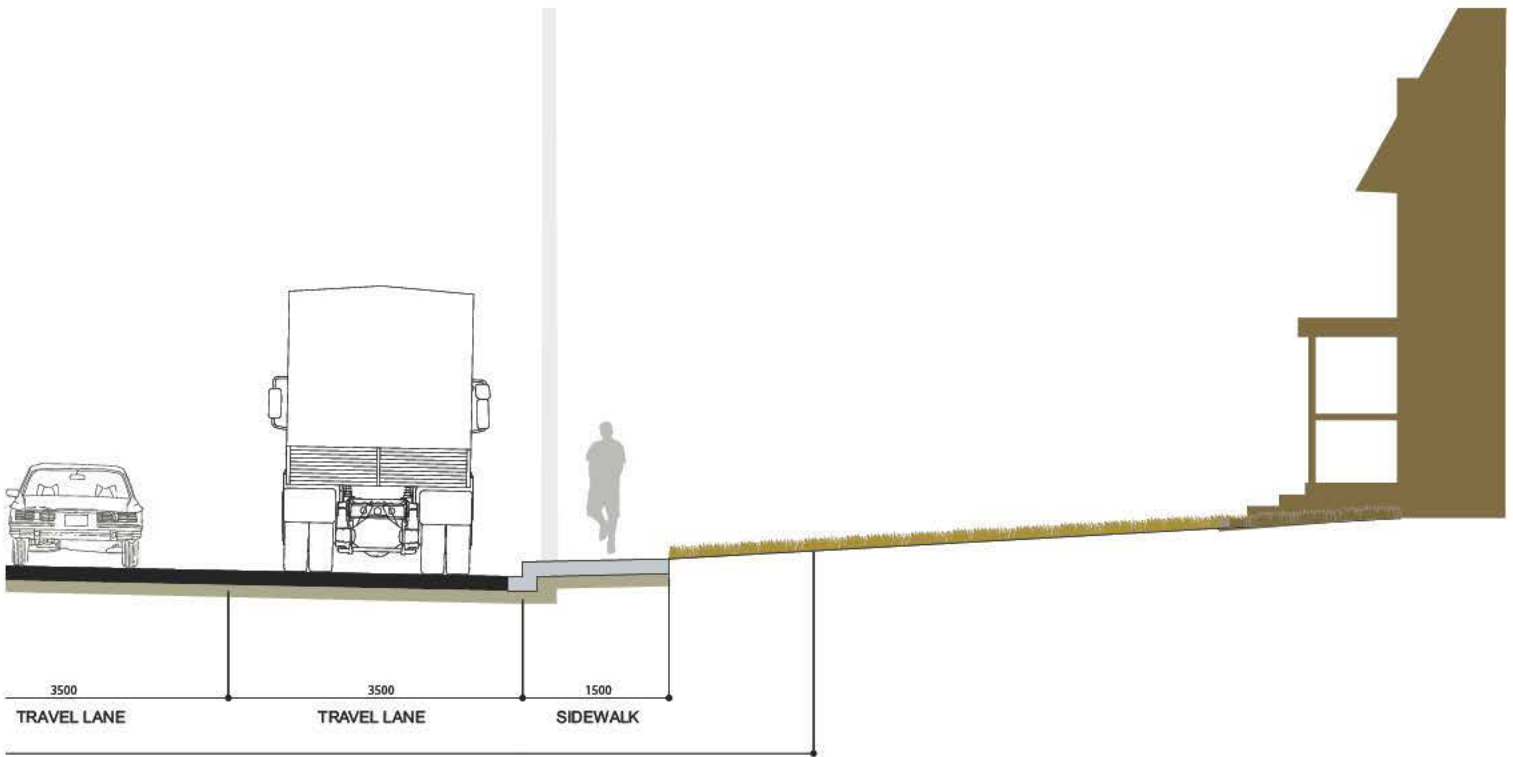

FIGURE 5.4 - PROPOSED SECTION AT BLOCK REDEVELOPMENT AREAS



# 5.1 TYPICAL ROAD SECTION: KING ROAD



figure 5.5

Street trees are important for King Township for their contribution to traffic calming, for their mitigation of vehicular emissions, and for the shade and buffering they provide to pedestrians. With tree planting, an emphasis must be placed on the design of growing space both above and below ground to create growing conditions that will support trees for future decades. A tree canopy is integral to the design of King City's streetscaping plan, and is fundamental to the image and quality of life in the Village Centre. Tree canopies provide positive modification to our climate, help to diminish water and air pollution, and provide a desirable environment.



figure 5.6



figure 5.8



figure 5.7

## *Acer ginnala* Amur Maple

The Amur Maple species are small trees chosen for their compact, regular form, their intense red fall colour, and their ability to tolerate salt and adverse growing conditions. In the spring, the trees flower with clusters of fragrant, yellowish-white flowers.





figure 5.9

## *Quercus rubra* Red Oak

Red Oaks are sturdy street trees tolerant of urban pollution. Leaves first emerge as reddish in colour, become dark green in the summer and turn varying shades of red in the fall.



figure 5.10



figure 5.11



figure 5.12



figure 5.13

*Melica ciliata* is an ornamental grass densely tufted with spike-like panicles pale green or tinged with purple that turn silky and white in the fall.

30



figure 5.16

*Panicum virgatum*, a native grass, creates a cloud-like inflorescence in the fall and maintains its form throughout the winter.



figure 5.14

Planting should be used to buffer parking areas



figure 5.15

Phragmites australis is a native grass that grows in wet conditions and is valued for its form, its hardiness and for its soil-cleaning and water filtration properties.

Seasonal planting is an important part of the streetscaping palette and can contribute greatly to the appearance of the Village Centre both for drivers and pedestrians. Due to high maintenance requirements, seasonal planting should be located in fewer and larger areas to maximize its visual impact. The consolidation of seasonal plantings will have an appropriate scale for the street and will provide greater efficiency for maintenance.

Plant material should be chosen for its ability to withstand the climate of King Township, for its visual interest throughout the year, and for ease of maintenance. Intricate planting patterns should be avoided; the preferred method is to use masses of low-maintenance plants placed at key locations to direct pedestrian traffic, screen parking lots and provide visual interest. Simplicity of plant character in keeping with the architectural palette will create a unified composition properly scaled to the width and heritage character of the street.

Low maintenance native and ornamental grasses create verticality and change throughout the year. Specific native species are commonly used around the perimeter of parking lots to filter runoff and lessen a dependency on stormwater sewers. All grasses retain their form throughout the year and change colour with the seasons. Potential planting could include the following.

#### Trees

- Amur Maple
- Red Oak
- Beech
- Hawthorn
- Sugar Maple

#### Tall Grasses and Bushes

- Switchgrass
- Dogwood
- Reedgrass
- Serviceberry
- Cottonwood

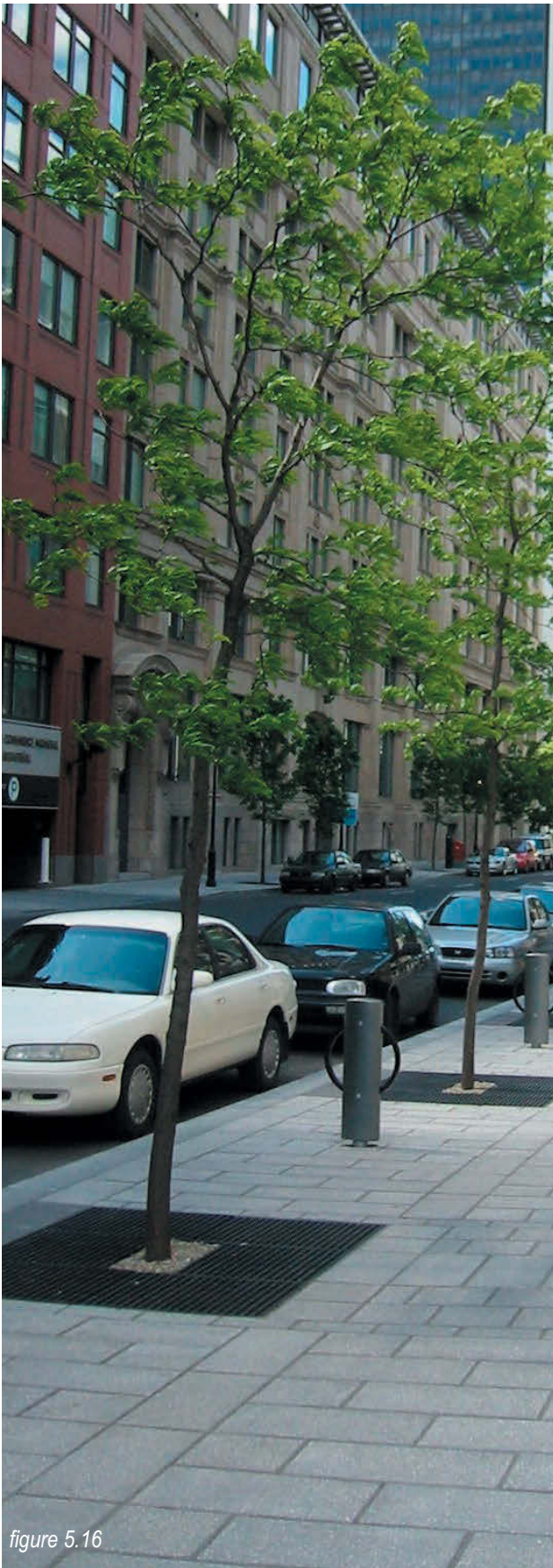

figure 5.16



figure 5.17



figure 5.18

To ensure that trees do not suffer from soil compaction that restricts water and air around their roots, the bases of trees should be either planted with groundcover or shrubs and mulch, or metal tree grates for areas with intense pedestrian traffic.

Adjustable tree grates that allow for the growth of the tree should be chosen. Gravel should be filled under the tree grate to prevent debris from accumulating between it and the finished planted grade.

## 5.4 TREE PROTECTION

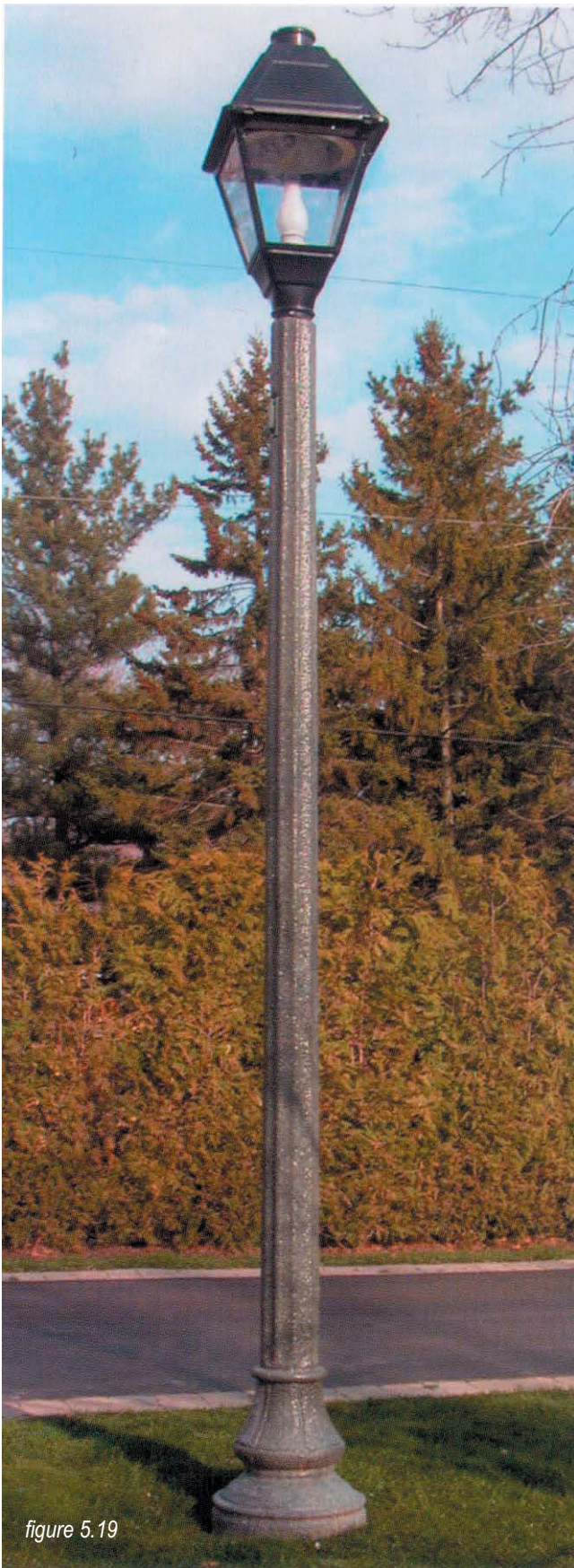

figure 5.19

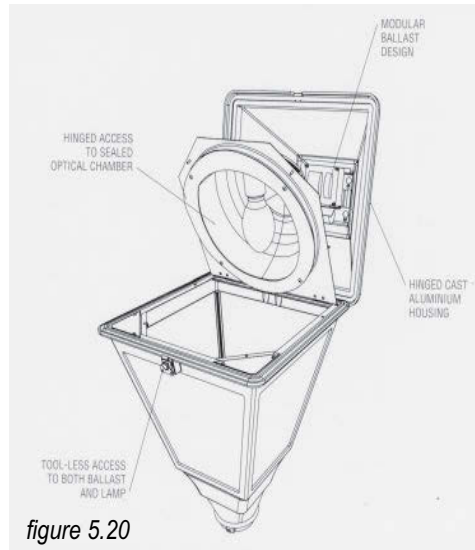

figure 5.20



figure 5.21

Street lighting should create well-lighted, beautiful and safe streetscapes.

One street light style has been chosen to create a uniform and coherent streetscape identity, and to facilitate future purchases.

A lantern style street light with heritage character is proposed for King City. Manufactured and distributed in Ontario, the lamp is easily maintained and has low glare characteristics.



figure 5.22



figure 5.24



figure 5.23



figure 5.25

34

## paving details

Paving details have been developed in different materials, from a simple concrete sidewalk to more detailed bands in concrete, red brick and granite unit pavers. A curb-edge decorative band clearly demarcates the boulevard strip and serves to put fixed objects like trees, parking metres and street lights in a boundary. The rough texture and contrasting colour not only have an aesthetic purpose, but also alert those who are visually impaired to obstacles and the edge of roadbeds.

## unit pavers

Unit pavers in the boulevard are separated from the concrete walk with an expansion joint to allow for thermal expansion. The pavers are dry laid in a sand setting bed and held in place by the curbs.

Unit pavers, saw cuts and trowel joints are located perpendicular to the curb edge and fanned at the street corners to limit the number of unit pavers to be custom cut. The bed under the unit pavers is poured-in-place unreinforced concrete with an integral curb next to the smooth walk. The two curbs provide a border for the pavers.

## sidewalks

Sidewalk surfaces are broom-finish concrete located behind the boulevard unit pavers. The surface is divided with trowel joints or saw cuts into 1200 and 1600mm units to control cracking and to allow for modular replacement.

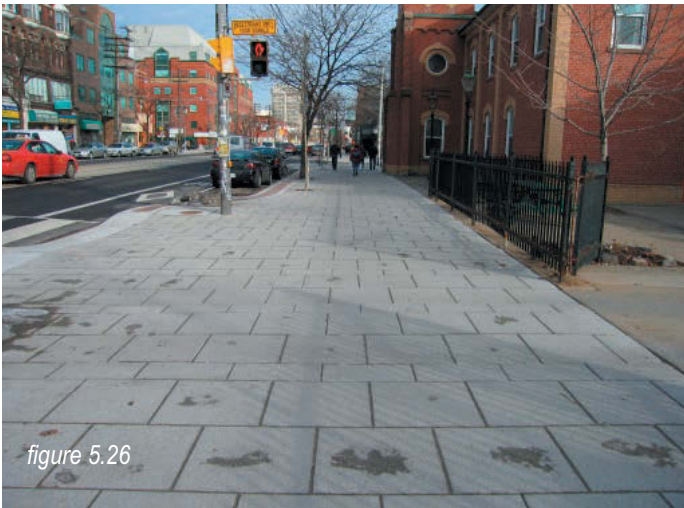

figure 5.26



figure 5.27



figure 5.28

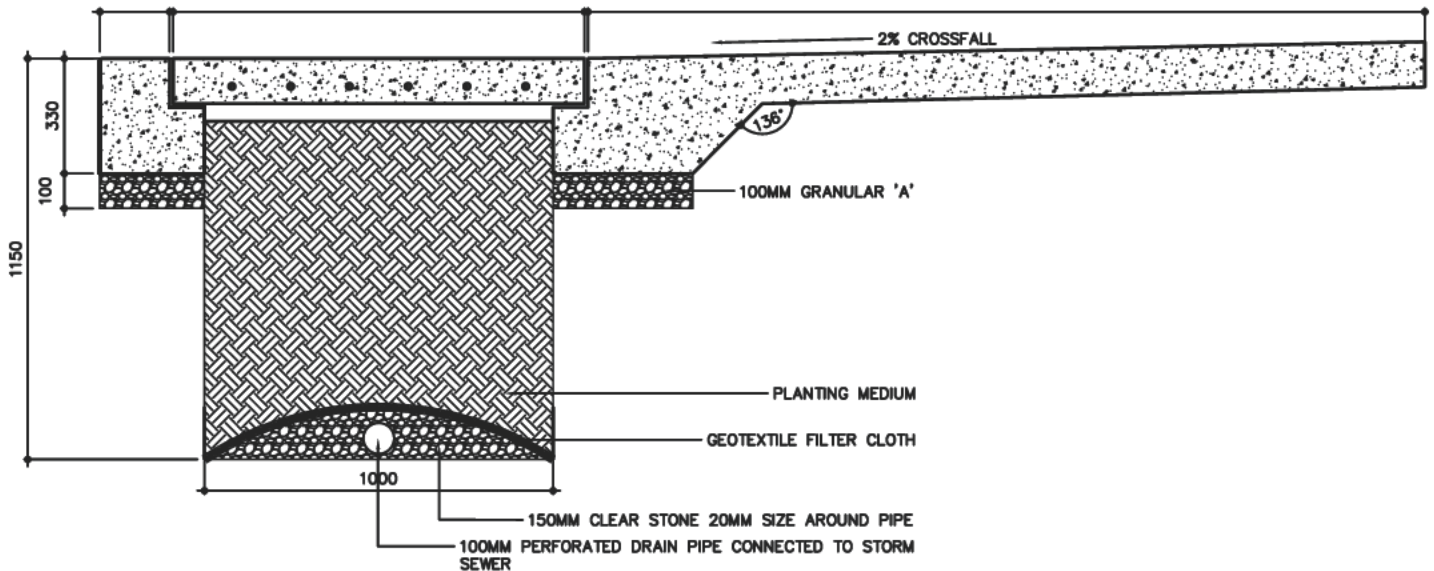

figure 5.29

## trench planting section a-a

Rows of street trees have been sited along King Road and Keele Street wherever the width of the sidewalk allows. Studies on urban trees consider water stress and insufficient room to grow the most common reasons for premature street tree death. Poor soil drainage, soil compaction, high salt levels and alkaline conditions also contribute to the problem of poor tree growth.

For a 6m canopy, a tree needs over 8.5 cu.m. of soil with good water holding capability to support it. To grow a tree 600mm in diameter, more than 34 cu. m. of rooting space is needed (approximately 6m x 6m x 1m). Ninety-five percent of tree roots grow in the upper 60cm of soil. The use of continuous tree trenches is thus encouraged.

Continuous tree pits are designed to maximize soil volume and greater water and oxygen infiltration; they provide more than 8.5 cu. m. of soil per tree. A continuous tree pit 1m deep, and 2m wide is excavated

prior to sidewalk construction. Drainage lines and uncompacted planting soil are placed in the trench, followed by a 100mm gravel cushion that allows air and water to flow between sidewalk and soil.

Where possible, trees have been designed to be planted in the ground and not in above ground planters that hinder growth and impede pedestrian circulation.

Tree planting is spaced at 6m on centre to form a continuous canopy structure and stem rhythm.

All planting has been designed to provide for the best conditions for the health of the tree, the volume of pedestrian traffic, adjacent land use, and building setback.

When street trees are planted in landscaped boulevard, the sodded area should be at least 1.6m wide with a minimum of 1.5m for the adjacent sidewalk.



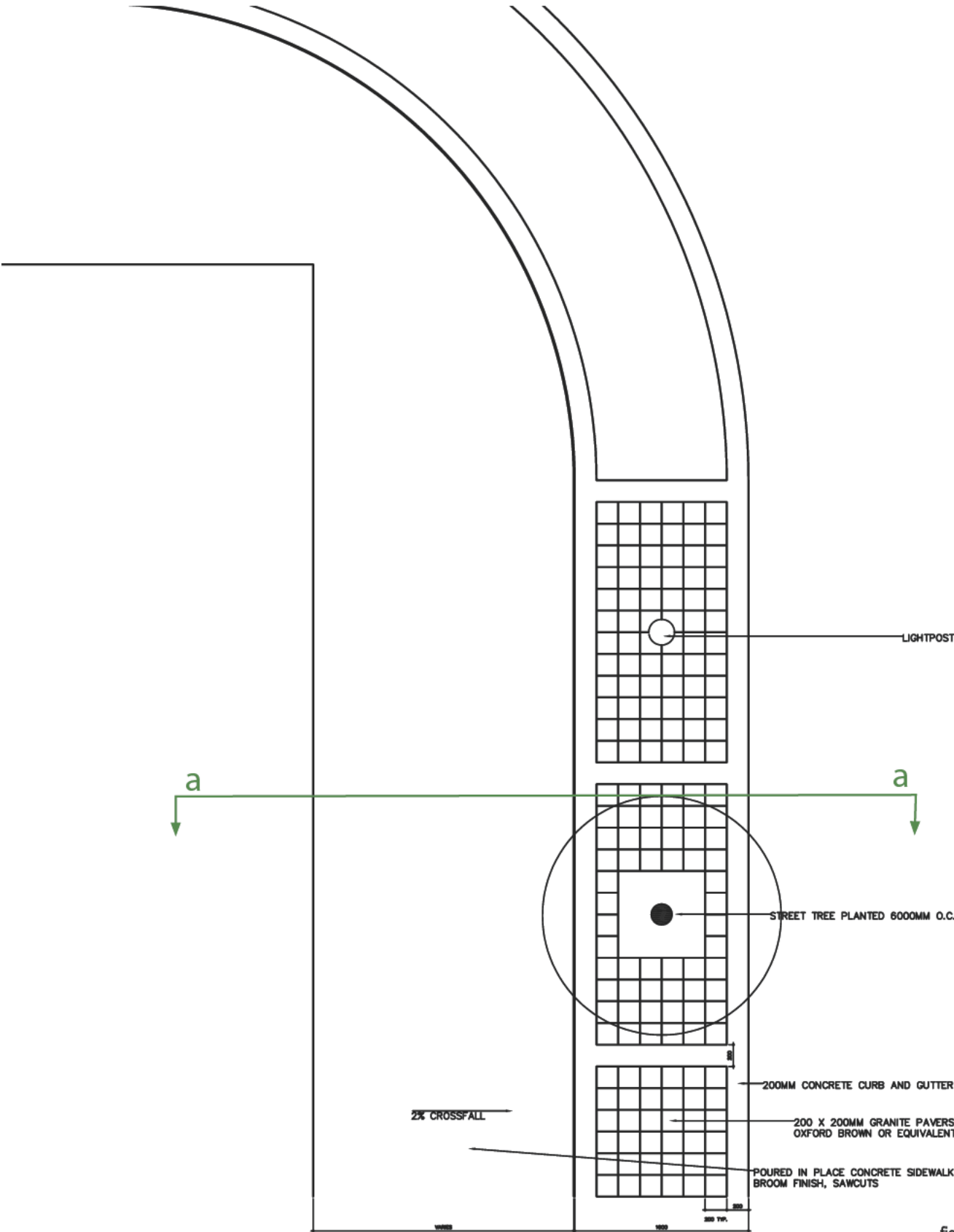
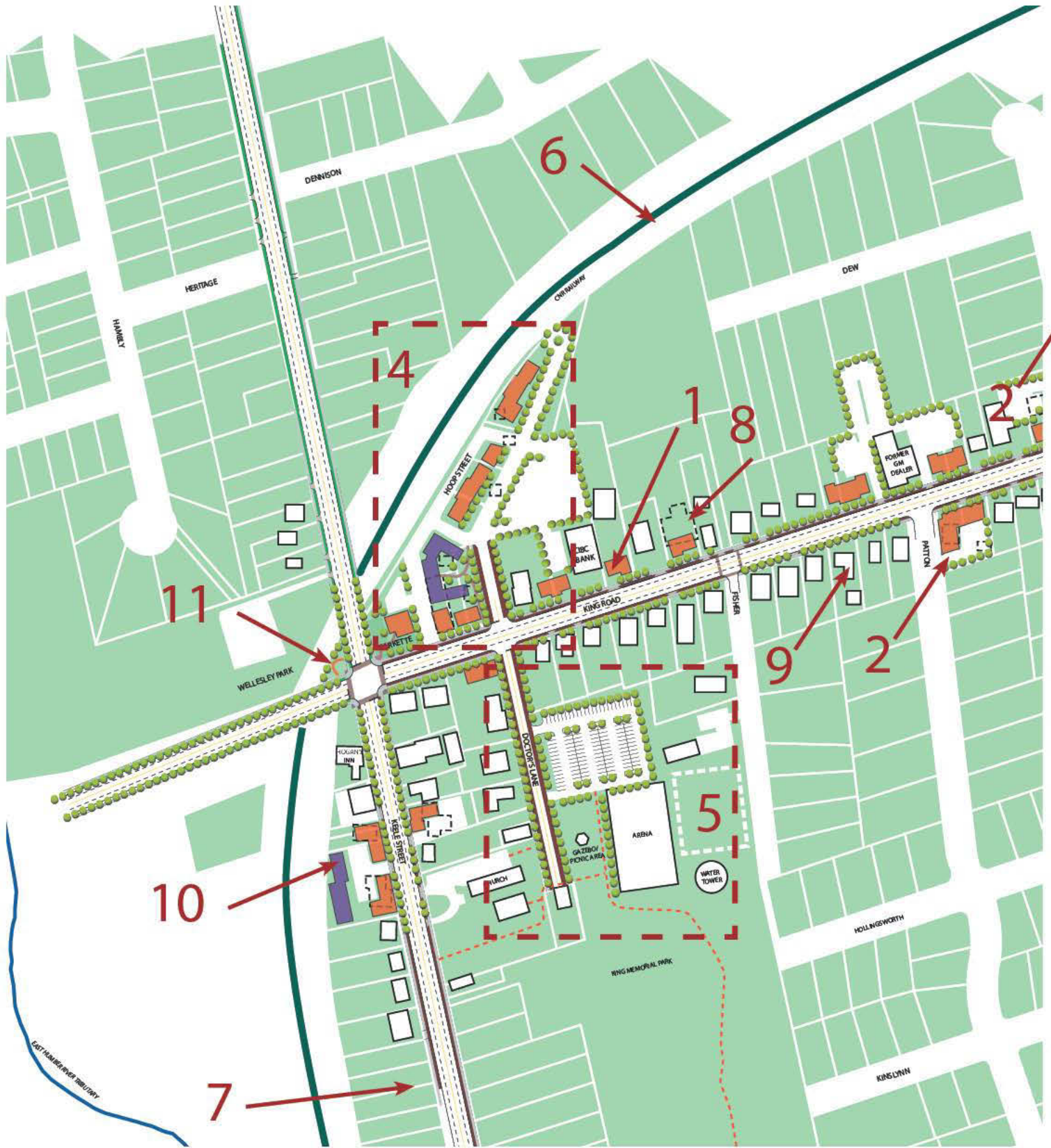

figure 5.30

sidewalk plan detail



6.1 - MAP OF KING CITY SHOWING POTENTIAL REDEVELOPMENT AREAS



figure 6.1

## Legend

- 1** Indicates proposed mixed-use redevelopment opportunities, typical
- 2** Parking located at rear of new developments allowing new building to define the street edge, typical
- 3** Key redevelopment site, King City Plaza
- 4** Key redevelopment site, Hoop Street Mews
- 5** Key redevelopment site, Doctor's Lane
- 6** Existing CNR rail line
- 7** Existing King City Land configuration, typical
- 8** Shows location of existing building for redevelopment, typical
- 9** Existing buildings, typical
- 10** Proposed residential redevelopment opportunities, typical
- 11** Proposed gateway feature to park

The redevelopment of the Municipal Offices and the plaza site into mixed use with residential buildings to the rear will create a new more vital eastern anchor for the King City community. The King Road buildings (shown in orange), could accommodate the new Township Offices and other commercial/retail uses. Front and side yard setbacks should provide space for restaurant patios. Parking is provided below grade with some surface parking at the rear. Access to rear parking is through a 'mews' type driveway that indicates pedestrian priority and is well landscaped.

The residential buildings (shown in purple), at the back of the property, have gardens fronting onto a new laneway. This residential typology will provide a new house type to the area.

Specific Urban Design recommendations include:

1. Future 3 storey buildings fronting on to King Road include mixed and institutional uses including the new Township of King offices. Parking is structured below grade. Some visitor parking is located at grade at the rear.
2. Future 3 storey townhouses are located behind the King Road buildings. 3 storey townhouses would permit at grade parking accessed by a rear lane behind each unit. Higher density townhouses or low rise apartments would require parking below grade. The any proposed additional storeys should be setback by a minimum of 2 metres to reduce the buildings visible mass.
3. Clapboard, brick and stone are the predominant village building materials and the use of these high quality, authentic materials is encouraged in new buildings, additions and renovations.
4. Locate future 2 to 3 storey mixed use or institutional building site on the north side of King Road. Parking is provided at grade behind the building.
5. Provide a continuous line of street trees where feasible within the public right of way. Buildings fronting King Road have a minimum 4.0 metre setback between the curb and the building face to allow for adequate space for street trees, the public sidewalk and other streetscape amenities including pedestrian scale lights, bicycle parking etc.



figure 6.2



figure 6.3



figure 6.4

## 6.2 PROPOSED KEY REDEVELOPMENT SITES

KING CITY URBAN DESIGN GUIDELINES

# hoop street mews concept plan



figure 6.5



figure 6.6

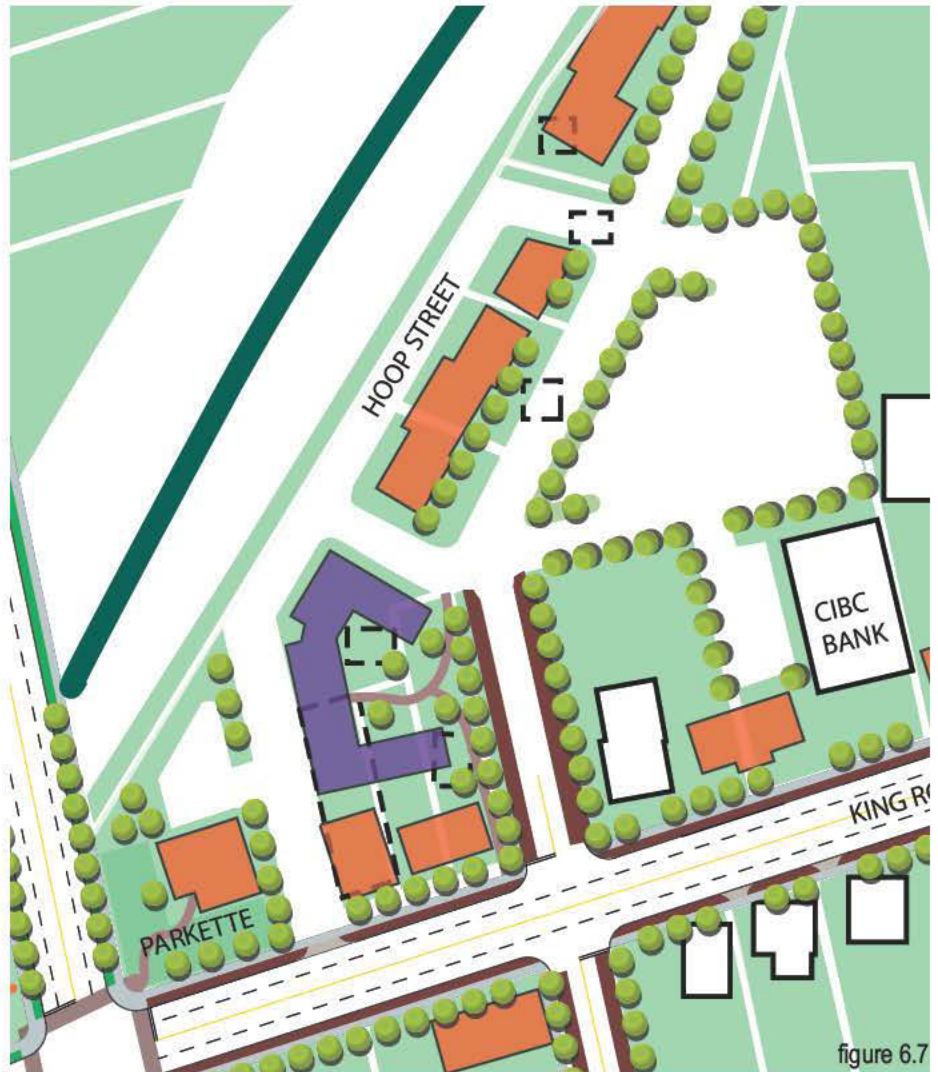

figure 6.7

The Hoop Street Mews is designed to define the western edge of the retail centre of the King City village. The mixed-use buildings are located at the sidewalk and have frontage on the street and parking behind. A new building at the corner of King Road west of Keele St. acts as a new informal gateway into the Village Centre.

Buildings fronting onto Hoop Street and the railway tracks could be residential or mixed-use. Retail may not be viable in this remote location, however, craft and/or artisan workshops with affordable studio or residential space would be appropriately located on a second storey above. All buildings are to be retail on the ground floor and office or residential above. All parking is to be located behind the buildings, like at the CIBC Bank shown in the figure above. All design concepts are to be coordinated with, and reviewed in relation to, other municipal objectives.

Specific Urban Design recommendations include:

1. Future retail and mixed use buildings front on to King Road and to Hoop Street Mews.
2. The Keele Street and King Road north east corner is

redeveloped with a new retail store, preferably a grocery store to replace the existing grocery store on this site.

3. Buildings are set close to the street, while providing a minimum 4.0m sidewalk and boulevard width between the curb and front building face.
4. Building heights are a minimum of 2 storeys and a maximum of 3 storeys
5. Hoop Street is redeveloped to provide pedestrian access only to new mixed use development.
6. Doctor's Lane is extended north into Hoop Street Mews providing access and parking to an area focused less on conventional main street retail and more on artisan, craft and/or artist studios. Other uses may include cafes, bookshops, galleries and other complementary uses.
7. Hoop Street Mews is lined with street trees, pedestrian scale lighting and feature red interlock paving to signal pedestrian priority to the area.
8. The parking area is tree lined and could provide a seasonal place for outdoor exhibits or craft displays.

## doctor's lane concept plan

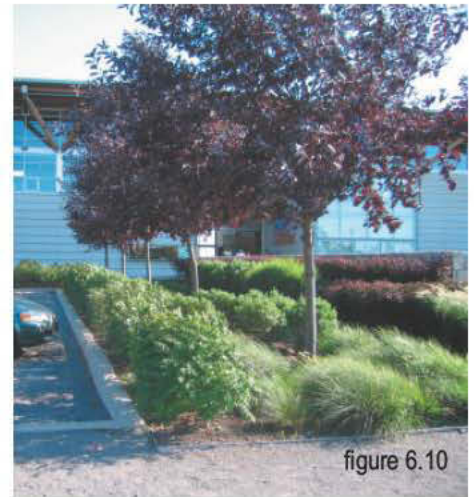
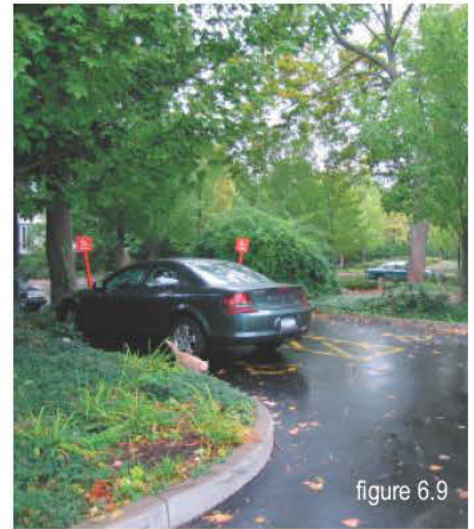
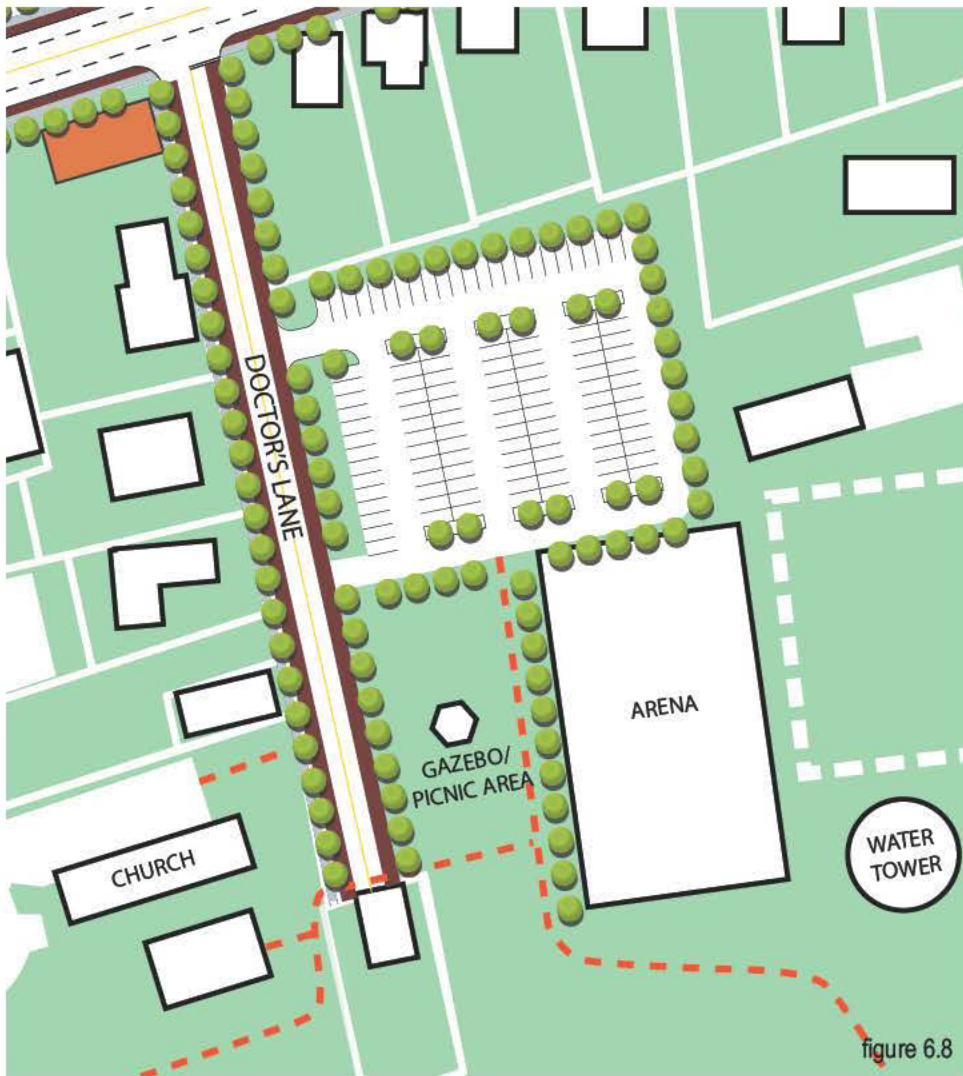

43

Doctor's Lane is a special area in the village: it is the entry point into the Arena and Memorial Park Recreation Area; it is the location of the post office; and it is in close proximity to the iconic Water Tower. Access to Keele Street via the church yard is also part of an enjoyable walking loop through the Village Centre.

This site is to be redesigned with pedestrian-friendly sidewalks, additional street trees, easier circulation for vehicles and a potential weekend market location. The redesign of the parking lot introduces trees and a special sidewalk treatment highlights the individual characteristics of the Lane. All design concepts are to be coordinated with, and reviewed in relation to, other municipal objectives.

Specific Urban Design recommendations include:

1. Future retail and mixed use buildings front on to King Road and to Doctor's Lane.
2. Buildings are set close to the street, while providing a minimum 4.0m sidewalk and boulevard width between the curb and front building face.
3. Building heights are a minimum of 2 storeys and a maximum of 3 storeys
4. Doctor's Lane is extended north into Hoop Street Mews providing access and parking to an area focused less on conventional main street retail and more on artisan, craft and/or artist studios. Other uses may include cafes, bookshops, galleries and other complementary uses.
5. Doctor's Lane is lined with street trees, pedestrian scale lighting and feature red interlock paving to signal pedestrian priority to the area.
6. The parking area is tree lined and could provide a seasonal place for outdoor exhibits or craft displays.
7. Building at corner of King Road and Doctor's Lane to accent the corner with an entry feature i.e. clock tower.

## 6.2 PROPOSED KEY REDEVELOPMENT SITES

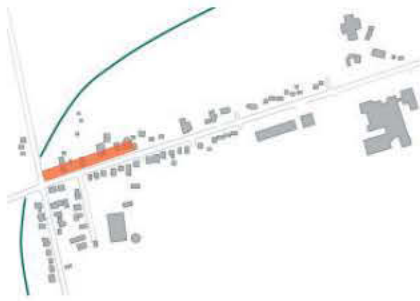

FIGURE 6.11 - NORTH SIDE OF KING ROAD STARTING AT KEELE STREET

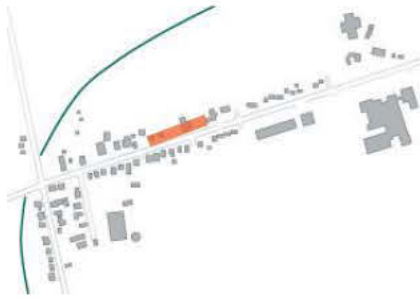

FIGURE 6.12 - NORTH SIDE OF KING ROAD CONTINUING FROM ABOVE

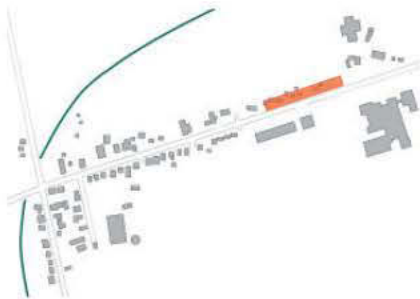

FIGURE 6.13 - NORTH SIDE OF KING ROAD CONTINUING FROM ABOVE

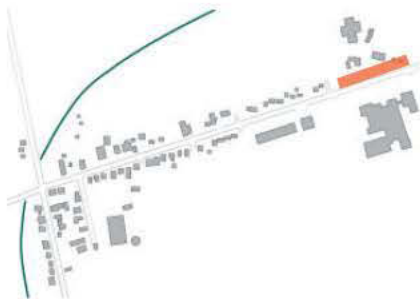

FIGURE 6.14 - NORTH SIDE OF KING ROAD CONTINUING FROM ABOVE





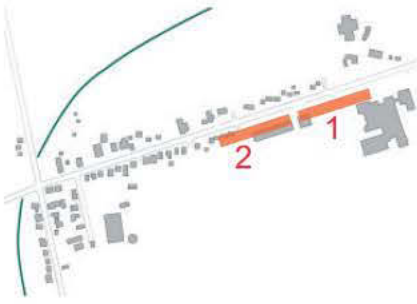

FIGURE 6.15 - SOUTH SIDE OF KING ROAD FROM THE FIRE STATION TO BANNER, AND AT PATTON

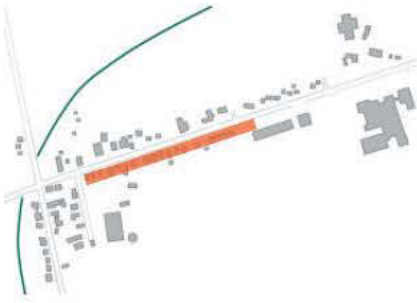

FIGURE 6.16- SOUTH SIDE OF KING ROAD FROM FISHER TO DOCTOR'S LANE

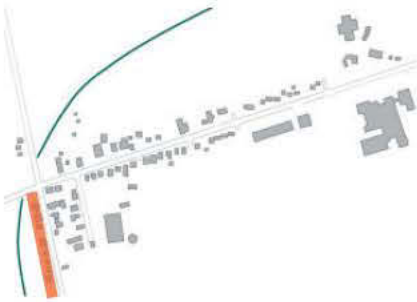

FIGURE 6.17 - WEST SIDE OF KEELE STREET ENDING AT KING ROAD

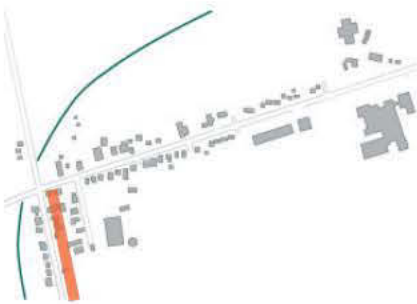

FIGURE 6.18 - EAST SIDE OF KEELE STREET ENDING AT KING ROAD

tail with residential behind



Entry into Doctor's Lane - potential new market and pedestrian area



47



## 6.3 PROPOSED STREET ELEVATIONS

KING CITY URBAN DESIGN GUIDELINES



## 7.1 A Guide

This document will be made available to the Mayor, King Township Councillors, residents, property owners, developers and builders to assist Township Staff in explaining desirable outcomes for King City. Over time, the Township of King will amend the document based on experience, trends and feedback from stakeholders.

## 7.2 A Vision for King City

Several recommendations and guidelines in the document require action by the Township to effect the desired outcome. The following list, broken down by Short-Term, Medium-Term and Long-Term, is intended to provide the Township with a clear road map to maintain and enhance the special character of the village in the years to come, even as development pressures may increase.

## 7.3 Short-term Initiatives: Immediate to One Year

- a) Adopt this document and prepare a communication plan to make this document available to all relevant stakeholders, on paper, and on the King Township's website.
- b) Explore linkages between this document and the municipal and regional policy frameworks. Namely, begin to review municipal standards and zoning bylaws for compatibility.
- c) Begin to use the document in site plan reviews and subdivision agreements.
- d) Begin to identify potential sources of funding and financing tools to implement public realm recommendations.
- e) Widely communicate the vision for the Village Centre to generate excitement and interest, including the local Chamber of Commerce.
- f) Develop a comprehensive streetscape plan for the Village Centre that includes design details for sidewalks, street trees planting, road widths and street furniture.

## 7.4 Medium-term Initiatives: One to Five Years

- a) Review the document.
- b) Complete the sidewalk updates for the urban area.
- c) Implement improvements in the Village Centre, including streetscaping, and the installation of street furniture,
- d) Adopt a historical signage strategy for King City that is compatible with Nobleton and Schomberg.
- e) Commence Street tree planting program.

## 7.5 Long-term Initiatives: Five Years and Beyond

- a) Review the document every 5 years and make necessary amendments and/or additions.
- b) In conjunction with Region of York initiatives regarding improvements to King Road and Keele Street including transportation and sewer projects, additional improvements to sidewalks (to unify any adjacent sidewalk widening) and pedestrian-scaled lighting should be considered.

49

## 7.6 Urban Design and the Policy Framework

Urban Design Guidelines cannot be fully implemented in isolation of other Township and Regional initiatives. Therefore, we suggest that the Urban Design Guidelines and policy recommendation in this document that are put forward by the Township be screened for possible links to the municipal and regional policy frameworks, including zoning, transportation strategies, local implementation of the Ontario Building Code and the fiscal framework. See Section 8.0 for specific policy recommendations.

- a) The Township and School Board should collaborate to ensure the future viability of the school by ensuring appropriate housing stock and after-hours programming of the school.
- b) The Township and Region could establish a task force to address the impact of regional roads on local communities.
- c) The Township should contemplate applying sustainable principles to public realm improvements and LEED (Leadership in Energy and Environmental Design) building standards on municipal buildings.

# 7.0 Implementation